



# 2020

PRODUCT GUIDE

**MV**  
MACHINE  
VISION  
LENSES



# INDEX

**03** 1" 20 MEGAPIXEL FIXED FOCAL LENS (MPZ Series)

**07** 1.1" 12 MEGAPIXEL FIXED FOCAL LENS (MPY Series)

**11** 2/3" 6 MEGAPIXEL FIXED FOCAL LENS (MPW3 Series)

**16** 2/3" 5 MEGAPIXEL FIXED FOCAL LENS (MPW2 Series)

**19** 2/3" 5 MEGAPIXEL RUGGEDIZED LENS (MPW2-R Series)

**20** 2/3" 1.5 MEGAPIXEL FIXED FOCAL LENS (MP2 Series)

**24** 2/3" 1 MEGAPIXEL VARI-FOCAL LENS

**25** MACRO ZOOM LENS

**27** TELECENTRIC MACRO LENS

**30** 1.1" 1" TELECENTRIC LENS

**32** 2/3" 2 MEGAPIXEL TELECENTRIC LENS

**40** ACCESSORIES

**41** SWIR (Short Wave Infrared) LENS

**43** 2/3" IR CORRECTIVE 5 MEGAPIXEL Lens for ITS

**45** MEGAPIXEL BOARD LENS

**46** MEGAPIXEL FISHEYE BOARD LENS

**47** TECHNICAL INFORMATION



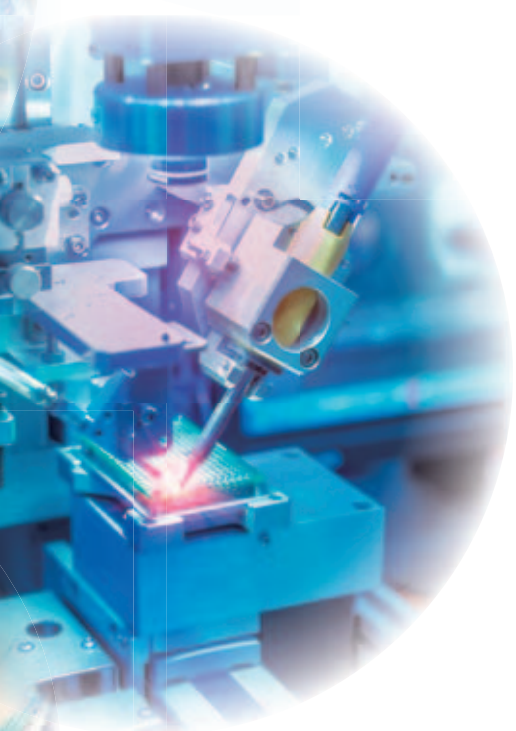

# computar®

"computar" is CBC's Group's brand of industrial lenses for more than 40 years history. It currently secures the top share in the industry for the global market, providing not only high performance and high quality but also a rich lineup of product groups with excellent cost performance.

The research and development structure and distribution structure to properly understand the needs of many users, promptly develop excellent products that meet various uses and purposes and supply them to the market in each country of the world are also "computar" brand's major assets, with the background of the CBC Group's enriched global network.



1" 20MP  
MPZ



- ✓ Ultra-high resolution lens, suitable for 1" 20 megapixel sensor
- ✓ Much lower distortion design for all models is beneficial for variety of machine vision applications
- ✓ The newest optical design, much higher relative illuminance compared to conventional models in spite of large format 1" sensor (Ø16mm)
- ✓ Vibration resistance up to 5G

# MPZ Series

1" 20 MEGAPIXEL Machine Vision Lens

Model No.	Format	Focal Length	F No.	Working Distance	Weight
V0826-MPZ	1"	8mm	F2.6-F16	0.1m-Inf.	203g
V1226-MPZ		12mm	F2.6-F16	0.1m-Inf.	98g
V1624-MPZ		16mm	F2.4-F16	0.1m-Inf.	108g
V2520-MPZ		25mm	F2.0-F16	0.15m-Inf.	73g
V3522-MPZ		35mm	F2.2-F16	0.2m-Inf.	118g
V5024-MPZ		50mm	F2.4-F16	0.2m-Inf.	138g
V7531-MPZ		75mm	F3.1-F16	0.25m-Inf.	176g

## Distortion Comparison

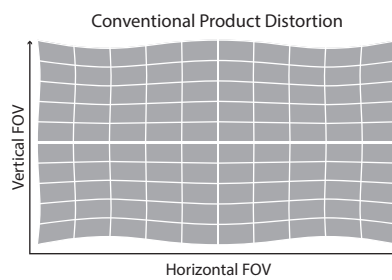
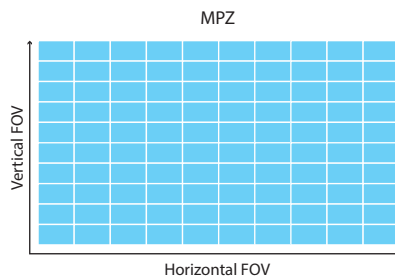

## V1624-MPZ Relative Illumination

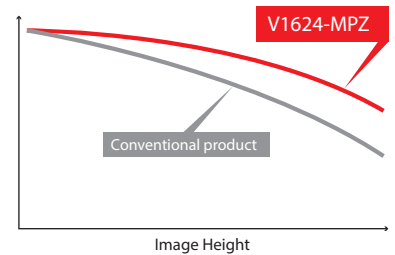

NEW

## V0826-MPZ

- 1"
- 20MP
- FIX
- MANUAL
- FLOATING



Focal Length	8mm				
Max. Aperture Ratio	1:2.6				
Max. Image Format	12.8mm x 9.6mm ( φ 16mm)				
Operation Range	Iris	F2.6 - F16.0			
	Focus	0.1m - Inf.			
Control	Iris	Manual			
	Focus	Manual			
Angle of View	D	88.8°	68.6°	58.2°	
	H	1" 76.9°	2/3" 57.1°	1/1.8" 47.8°	
	V	61.5°	44.2°	36.6°	
Operating Temperature	-10°C ~ +50°C				

Optical Distortion	1"	-0.8%(y=8.0)	2/3"	-2.1%(y=5.5)	1/1.8"	-1.9%(y=4.5)
Back Focal Length	10.6mm					
Flange Back Length	17.526mm					
Mount	C-Mount					
Filter Size	M82 P=0.75mm*					
Dimensions	φ 69.5mm x 52.93mm					
	φ 85.0mm x 53.83mm (with ZM0810)					
Weight	203g					

Working Distance (mm)	Optical Magnification	Extension Ring (mm)	Field of View (mm)					
			1"		2/3"		1/1.8"	
			H	V	H	V	H	V
1000	0.009	-	1619.6	1211.4	1108.2	825.6	902.4	672.9
950	0.009	-	1540.2	1151.9	1053.8	785.0	858.0	639.8
900	0.009	-	1460.8	1092.4	999.3	744.4	813.6	606.7
850	0.010	-	1381.4	1032.9	944.9	703.8	769.3	573.6
800	0.011	-	1302.0	973.4	890.4	663.2	724.9	540.5
750	0.011	-	1222.7	913.9	835.9	622.6	680.5	507.4
700	0.012	-	1143.3	854.4	781.5	582.0	636.2	474.3
650	0.013	-	1063.9	794.9	727.0	541.4	591.8	441.3
600	0.014	-	984.5	735.4	672.6	500.8	547.5	408.2
550	0.015	-	905.1	675.9	618.1	460.2	503.1	375.1
500	0.016	-	825.7	616.3	563.7	419.6	458.7	342.0
450	0.018	-	746.3	556.8	509.2	379.0	414.4	308.9
400	0.020	-	666.9	497.3	454.7	338.4	370.0	275.8
350	0.023	-	587.5	437.8	400.3	297.8	325.6	242.7
300	0.027	-	508.0	378.3	345.8	257.2	281.2	209.6
250	0.031	-	428.6	318.7	291.3	216.6	236.9	176.5
200	0.039	-	349.1	259.2	236.8	176.0	192.5	143.4
150	0.050	-	269.6	199.6	182.3	135.4	148.1	110.3
100	0.071	-	189.9	140.0	127.8	94.8	103.7	77.2

\*There is no filter mount on the top of the lens.  
For using filters, please attach ZM0810.  
For more detail, please refer to P40.

Field of View = CCD Size / Optical Magnification



# 1" 20 MEGA PIXEL FIXED FOCAL LENS (MPZ Series)



**NEW**

## V1226-MPZ

1"

20MP

FIX

MANUAL

FLOATING

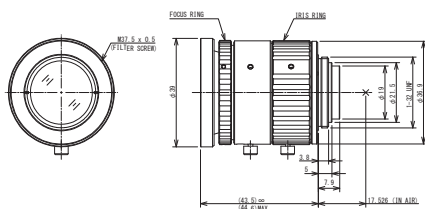

Focal Length	12mm				
Max. Aperture Ratio	1:2.6				
Max. Image Format	12.8mm x 9.6mm ( $\phi$ 16mm)				
Operation Range	Iris	F2.6 - F16.0			
	Focus	0.1m - Inf.			
Control	Iris	Manual			
	Focus	Manual			
Angle of View	D	67.4°	49.8°	41.5°	
	H	1" 56.7°	2/3" 40.7°	1/1.8" 33.7°	
	V	44.1°	31.0°	25.5°	
Operating Temperature	-10°C ~ +50°C				

Optical Distortion	1"	0.0%(y=8.0)	2/3"	-1.1%(y=5.5)	1/1.8"	-1.0%(y=4.5)
Back Focal Length	10.6mm					
Flange Back Length	17.526mm					
Mount	C-Mount					
Filter Size	M37.5 P=0.5mm					
Dimensions	$\phi$ 39mm x 43.5mm					
Weight	98g					

Working Distance (mm)	Optical Magnification	Extension Ring (mm)	Field of View (mm)					
			1"		2/3"		1/1.8"	
			H	V	H	V	H	V
1000	0.012	-	1093.8	819.7	750.6	561.0	612.6	458.2
950	0.013	-	1039.9	779.2	713.6	533.3	582.4	435.6
900	0.014	-	986.0	738.8	676.5	505.7	552.2	413.0
850	0.014	-	932.1	698.4	639.5	478.0	522.0	390.3
800	0.015	-	878.1	658.0	602.5	450.3	491.7	367.7
750	0.016	-	824.2	617.5	565.5	422.6	461.5	345.1
700	0.017	-	770.3	577.1	528.5	395.0	431.3	322.5
650	0.019	-	716.4	536.7	491.4	367.3	401.1	299.9
600	0.020	-	662.5	496.3	454.4	339.6	370.8	277.3
550	0.022	-	608.5	455.8	417.4	311.9	340.6	254.7
500	0.024	-	554.6	415.4	380.4	284.3	310.4	232.1
450	0.026	-	500.7	375.0	343.3	256.6	280.2	209.5
400	0.029	-	446.8	334.6	306.3	228.9	250.0	186.9
350	0.033	-	392.9	294.1	269.3	201.2	219.7	164.3
300	0.039	-	338.9	253.7	232.3	173.5	189.5	141.7
250	0.046	-	285.0	213.3	195.3	145.9	159.3	119.1
200	0.057	-	231.1	172.9	158.2	118.2	129.1	96.5
150	0.074	-	177.2	132.4	121.2	90.5	98.9	73.9
100	0.106	-	123.2	92.0	84.2	62.8	68.6	51.3

Field of View = CCD Size / Optical Magnification

**NEW**

## V1624-MPZ

1"

20MP

FIX

MANUAL

FLOATING

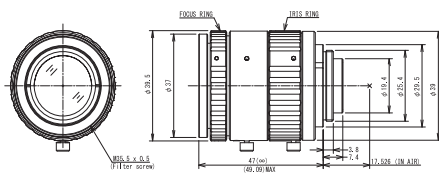

Focal Length	16mm				
Max. Aperture Ratio	1:2.4				
Max. Image Format	12.8mm x 9.6mm ( $\phi$ 16mm)				
Operation Range	Iris	F2.4 - F16.0			
	Focus	0.1m - Inf.			
Control	Iris	Manual			
	Focus	Manual			
Angle of View	D	53.2°	38.1°	31.6°	
	H	1" 43.8°	2/3" 30.9°	1/1.8" 25.5°	
	V	33.6°	23.4°	19.2°	
Operating Temperature	-10°C ~ +50°C				

Optical Distortion	1"	0.0%(y=8.0)	2/3"	-0.4%(y=5.5)	1/1.8"	-0.4%(y=4.5)
Back Focal Length	10.7mm					
Flange Back Length	17.526mm					
Mount	C-Mount					
Filter Size	M35.5 P=0.5mm					
Dimensions	$\phi$ 39.5mm x 47mm					
Weight	108g					

Working Distance (mm)	Optical Magnification	Extension Ring (mm)	Field of View (mm)					
			1"		2/3"		1/1.8"	
			H	V	H	V	H	V
1000	0.016	-	811.4	608.4	557.5	417.6	455.7	341.5
950	0.017	-	771.2	578.2	529.9	396.9	433.2	324.6
900	0.018	-	761.1	548.1	502.3	376.6	410.6	370.7
850	0.019	-	690.9	518.0	474.7	355.6	388.0	290.7
800	0.020	-	650.8	487.9	447.1	334.9	365.5	273.8
750	0.022	-	610.6	457.8	419.5	314.2	342.9	256.9
700	0.023	-	570.5	427.7	391.9	293.6	320.4	240.0
650	0.025	-	530.3	397.6	364.3	272.9	297.8	223.1
600	0.027	-	490.2	367.4	336.7	252.2	275.2	206.2
550	0.029	-	450.0	337.3	309.1	231.5	252.7	189.3
500	0.032	-	409.8	307.2	281.5	210.9	230.1	172.4
450	0.035	-	369.7	277.1	253.9	190.2	207.6	155.5
400	0.039	-	329.5	247.0	226.3	169.5	185.0	138.6
350	0.045	-	289.4	216.9	198.7	148.8	162.4	121.7
300	0.052	-	249.2	186.8	171.1	128.2	139.9	104.8
250	0.062	-	209.1	156.6	143.5	107.5	117.3	87.9
200	0.077	-	168.9	126.5	115.9	86.8	94.8	71.0
150	0.101	-	128.7	96.4	88.3	66.2	72.2	54.1
100	0.146	-	88.6	66.3	60.7	45.5	49.6	37.2

Field of View = CCD Size / Optical Magnification



1" 20MP  
MPZ

# 1" 20 MEGA PIXEL FIXED FOCAL LENS (MPZ Series)

- 8, 12, 16, 25, 35, 50, 75mm 7 lens series
- Compatible with 1" (φ 16mm) large format sensor
- Vibration resistance up to 5G
- Ultra-high resolution 20MP
- Ultra-low distortion design

**NEW**

## V2520-MPZ

- 1"
- 20MP
- FIX
- MANUAL
- FLOATING

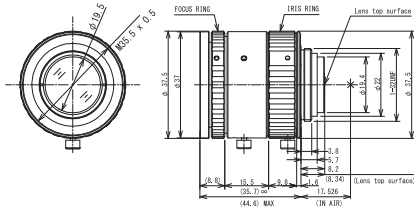

Focal Length	25mm					
Max. Aperture Ratio	1:2.0					
Max. Image Format	12.8mm x 9.6mm (φ 16mm)					
Operation Range	Iris	F2.0 - F16.0				
	Focus	0.15m - Inf.				
Control	Iris	Manual				
	Focus	Manual				
Angle of View	D	35.5°	24.9°	20.5°		
	H	28.8°	2/3" 20.0°	1/1.8" 16.4°		
	V	21.8°	15.1°	12.4°		
Operating Temperature	-10°C ~ +50°C					

Optical Distortion	1"	0.0%(y=8.0)	2/3"	0.0%(y=5.5)	1/1.8"	0.0%(y=4.5)
Back Focal Length	9.1mm					
Flange Back Length	17.526mm					
Mount	C-Mount					
Filter Size	M35.5 P=0.5mm					
Dimensions	φ 37.5mm x 35.5mm					
Weight	73g					

Working Distance (mm)	Optical Magnification	Extension Ring (mm)	Field of View (mm)					
			1"		2/3"		1/1.8"	
			H	V	H	V	H	V
1000	0.026	-	502.6	376.9	345.4	259.0	282.6	211.9
950	0.027	-	476.9	357.6	327.8	245.8	264.1	201.1
900	0.028	-	451.3	338.4	310.1	232.6	253.7	190.3
850	0.030	-	425.7	319.2	292.5	219.4	239.3	179.5
800	0.032	-	400.1	300.0	274.9	206.2	224.9	168.7
750	0.034	-	374.5	280.7	257.3	193.0	210.5	157.9
700	0.037	-	348.9	261.5	239.7	179.7	196.1	147.1
650	0.040	-	323.3	242.3	222.1	166.5	181.7	136.3
600	0.043	-	297.7	223.1	204.5	153.3	167.3	125.5
550	0.047	-	272.1	203.9	186.9	140.1	152.9	114.6
500	0.052	-	246.4	184.7	169.3	126.9	138.5	103.8
450	0.058	-	220.8	165.5	151.7	113.7	124.1	93.0
400	0.066	-	195.2	146.3	134.1	100.5	109.7	82.2
350	0.076	-	169.6	127.1	116.5	87.3	95.3	71.4
300	0.089	-	143.9	107.8	98.8	74.1	80.8	60.6
250	0.109	-	118.3	88.6	81.2	60.9	66.4	49.8
200	0.139	-	92.7	69.4	63.6	47.7	52.0	39.0
150	0.192	-	67.0	50.2	46.0	34.5	37.6	28.2
100	0.312	5.0	41.4	31.0	28.4	21.3	23.2	17.4

Field of View = CCD Size / Optical Magnification

**NEW**

## V3522-MPZ

- 1"
- 20MP
- FIX
- MANUAL
- FLOATING

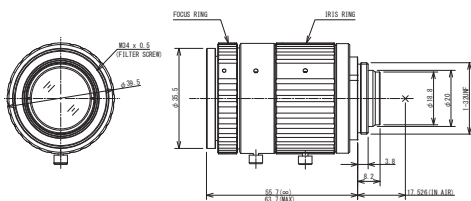

Focal Length	35mm					
Max. Aperture Ratio	1:2.2					
Max. Image Format	12.8mm x 9.6mm (φ 16mm)					
Operation Range	Iris	F2.2 - F16.0				
	Focus	0.2m - Inf.				
Control	Iris	Manual				
	Focus	Manual				
Angle of View	D	25.8°	17.9°	14.7°		
	H	20.8°	2/3" 14.4°	1/1.8" 11.8°		
	V	15.7°	10.8°	8.9°		
Operating Temperature	-10°C ~ +50°C					

Optical Distortion	1"	0.0%(y=8.0)	2/3"	0.0%(y=5.5)	1/1.8"	0.0%(y=4.5)
Back Focal Length	9.7mm					
Flange Back Length	17.526mm					
Mount	C-Mount					
Filter Size	M34 P=0.5mm					
Dimensions	φ 39.5mm x 55.7mm					
Weight	118g					

Working Distance (mm)	Optical Magnification	Extension Ring (mm)	Field of View (mm)					
			1"		2/3"		1/1.8"	
			H	V	H	V	H	V
1000	0.035	-	362.4	271.8	249.1	186.8	203.8	152.9
950	0.037	-	344.1	258.1	236.6	177.4	193.5	145.1
900	0.039	-	325.8	244.3	224.0	168.0	183.2	137.4
850	0.042	-	307.6	230.6	211.4	158.5	173.0	129.7
800	0.044	-	289.3	216.9	198.8	149.1	162.7	122.0
750	0.047	-	271.0	203.2	186.3	139.7	152.4	114.3
700	0.051	-	252.7	189.5	173.7	130.3	142.1	106.6
650	0.055	-	234.4	175.8	161.1	120.8	131.8	98.9
600	0.059	-	216.1	162.1	148.5	111.4	121.5	91.1
550	0.065	-	197.8	148.3	136.0	102.0	111.2	83.4
500	0.071	-	179.5	134.6	123.4	92.5	101.0	75.7
450	0.080	-	161.2	120.9	110.8	83.1	90.7	68.0
400	0.090	-	142.9	107.2	98.2	73.7	80.4	60.3
350	0.103	-	124.7	93.5	85.7	64.3	80.1	52.6
300	0.121	-	106.4	79.7	73.1	54.8	59.8	44.9
250	0.146	-	88.1	66.0	60.5	45.4	49.5	37.1
200	0.184	-	69.9	52.4	48.0	36.0	39.3	29.5
150	0.249	2.5	51.7	38.7	35.5	26.6	29.0	21.8
100	0.385	7.0	33.5	25.1	23.0	17.2	18.8	14.1

Field of View = CCD Size / Optical Magnification



# 1" 20 MEGAPIXEL FIXED FOCAL LENS (MPZ Series)



**NEW**

## V5024-MPZ

1"

20MP

FIX

MANUAL

FLOATING



Focal Length	50mm				
Max. Aperture Ratio	1:2.4				
Max. Image Format	12.8mm x 9.6mm (φ 16mm)				
Operation Range	Iris	F2.4 - F16.0			
	Focus	0.2m - Inf.			
Control	Iris	Manual			
	Focus	Manual			
Angle of View	D	18.2°	12.6°	10.3°	
	H	1" 14.6°	2/3" 10.1°	1/1.8" 8.3°	
	V	11.0°	7.6°	6.2°	
Operating Temperature	-10°C ~ +50°C				

Optical Distortion	1"	0.0%(y=8.0)	2/3"	0.0%(y=5.5)	1/1.8"	0.0%(y=4.5)
Back Focal Length	11.1mm					
Flange Back Length	17.526mm					
Mount	C-Mount					
Filter Size	M30.5 P=0.5mm					
Dimensions	φ 69.5mm x 52.93mm					
Weight	138g					

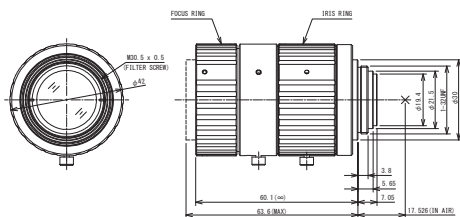

Working Distance (mm)	Optical Magnification	Extension Ring (mm)	Field of View (mm)					
			1"		2/3"		1/1.8"	
			H	V	H	V	H	V
1000	0.053	-	245.9	184.4	169.0	126.8	138.3	103.8
950	0.055	-	233.1	174.8	160.2	120.2	131.1	98.4
900	0.059	-	220.3	165.2	151.4	113.6	123.9	93.0
850	0.062	-	207.5	155.6	142.6	107.0	116.7	87.5
800	0.066	-	194.7	146.0	133.8	100.4	109.5	82.1
750	0.071	-	181.9	136.4	125.0	93.8	102.3	76.7
700	0.076	-	169.2	126.9	116.3	87.2	95.1	71.4
650	0.082	-	156.3	117.2	107.4	80.6	87.9	65.9
600	0.090	-	143.5	107.6	98.6	74.0	80.7	60.5
550	0.098	-	130.7	98.0	89.8	67.4	735.0	55.1
500	0.109	-	118.0	88.5	81.1	60.8	66.4	49.8
450	0.122	-	105.1	78.8	72.2	54.2	59.1	44.3
400	0.139	-	92.3	69.2	63.4	47.6	51.9	38.9
350	0.162	-	79.5	59.6	54.6	41.0	44.7	33.5
300	0.193	-	66.7	50.0	45.8	34.4	37.5	28.1
250	0.239	-	53.8	40.4	37.0	27.8	30.3	22.7
200	0.313	-	41.0	30.8	28.2	21.2	23.1	17.3
150	0.455	8.5	28.2	21.2	19.4	14.6	15.9	11.9
100	0.835	30.0	15.4	11.6	10.6	8.0	8.7	6.5

Field of View = CCD Size / Optical Magnification

**NEW**

## V7531-MPZ

1"

20MP

FIX

MANUAL

FLOATING



Focal Length	75mm				
Max. Aperture Ratio	1:3.1				
Max. Image Format	12.8mm x 9.6mm (φ 16mm)				
Operation Range	Iris	F3.1 - F16.0			
	Focus	0.25m - Inf.			
Control	Iris	Manual			
	Focus	Manual			
Angle of View	D	12.2°	8.4°	6.9°	
	H	1" 9.8°	2/3" 6.7°	1/1.8" 5.5°	
	V	7.3°	5.0°	4.1°	
Operating Temperature	-10°C ~ +50°C				

Optical Distortion	1"	0.0%(y=8.0)	2/3"	0.0%(y=5.5)	1/1.8"	0.0%(y=4.5)
Back Focal Length	12.0mm					
Flange Back Length	17.526mm					
Mount	C-Mount					
Filter Size	M30.5 P=0.5mm					
Dimensions	φ 42.0mm x 79.8mm					
Weight	176g					

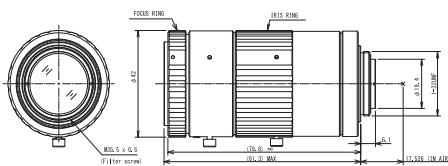

Working Distance (mm)	Optical Magnification	Extension Ring (mm)	Field of View (mm)					
			1"		2/3"		1/1.8"	
			H	V	H	V	H	V
1000	0.077	-	166.9	12.5	114.8	86.1	93.9	70.4
950	0.081	-	158.4	118.8	108.9	81.7	89.1	66.8
900	0.086	-	149.8	112.4	103.0	77.3	84.3	63.2
850	0.091	-	141.3	106.0	97.2	72.9	79.5	59.6
800	0.097	-	132.8	99.6	91.3	68.5	74.7	56.0
750	0.104	-	124.2	93.2	85.4	64.1	69.9	52.4
700	0.111	-	115.7	86.8	79.6	59.7	65.1	48.8
650	0.120	-	107.2	80.4	73.7	55.3	60.3	45.2
600	0.130	-	98.6	74.0	67.8	50.9	55.5	41.6
550	0.143	-	90.1	67.6	62.0	46.5	50.7	38.0
500	0.158	-	81.6	61.2	56.1	42.1	45.9	34.4
450	0.176	-	73.0	54.8	50.2	37.7	41.1	30.8
400	0.199	-	64.5	48.4	44.4	33.3	36.3	27.2
350	0.229	-	56.0	42.0	38.5	28.9	31.5	23.6
300	0.271	-	47.4	35.6	32.6	24.5	26.7	20.0
250	0.330	-	38.9	29.2	26.8	20.1	21.9	16.4
200	0.425	7.0	30.2	22.7	20.8	15.6	17.0	12.8
150	0.598	19.5	21.5	16.1	14.8	11.1	12.1	9.1
100	1.009	50.0	12.8	9.6	8.8	6.6	7.2	5.4

Field of View = CCD Size / Optical Magnification



1.1" 12MP  
MPY



- Ultra-high resolution lens, suitable for 1.1" 12 megapixel sensor
- Enlarged image circle up to  $\varnothing 17.6\text{mm}$  (1.1" sensor). The most compact, lightweight lens design on the machine vision market
- Floating design achieves ultra-high resolution in the whole range of near focus to infinity
- Vibration resistance up to 5G

# MPY Series

1.1" 12 MEGAPIXEL Machine Vision Lens

Model No.	Format	Focal Length	F No.	Working Distance	Weight
V0828-MPY2	1.1"	8mm	F2.8-F16	0.2m-Inf.	155g
V1228-MPY2		12mm		0.3m-Inf.	98g
V1628-MPY2		16mm		0.3m-Inf.	91g
V2528-MPY		25mm		0.3m-Inf.	78g
V3528-MPY		35mm		0.3m-Inf.	103g
V5028-MPY		50mm		0.5m-Inf.	107g

MPY Series Corner Resolution  
NEAR

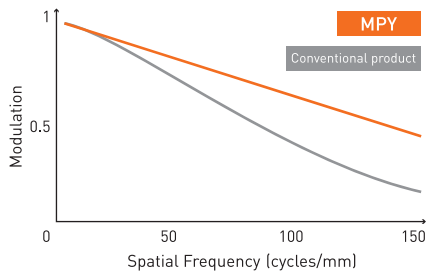

INF

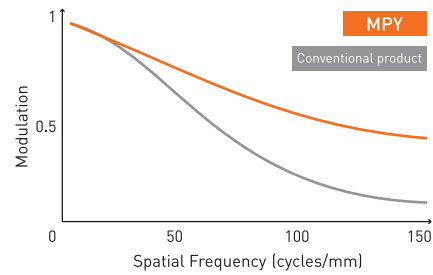

## V0828-MPY2

- 1.1"
- 12MP
- FIX
- MANUAL
- FLOATING



Focal Length	8mm				
Max. Aperture Ratio	1:2.8				
Max. Image Format	14.2mm x 10.4mm ( $\varnothing$ 17.6mm)				
Operation Range	Iris	F2.8 - F16.0			
	Focus	0.2m - Inf.			
Control	Iris	Manual			
	Focus	Manual			
Angle of View	D	93.9°	89.3°	69.0°	
	H	1.1" 83.0°	1" 77.3°	2/3" 57.3°	
	V	66.0°	61.7°	44.2°	
Operating Temperature	-10°C ~ +50°C				

Optical Distortion	1.1" -0.6%(y=8.8)	1" -1.7%(y=8.0)	2/3" -2.8%(y=5.5)		
Back Focal Length	8.6mm				
Flange Back Length	17.526mm				
Mount	C-Mount				
Filter Size	M72 P=0.75mm (with VM0811)*				
	M67 P=0.75mm (with VM0810)*				
Dimensions	$\varnothing$ 75mm x 54mm				
Weight	157g				

Working Distance (mm)	Optical Magnification	Extension Ring (mm)	Field of View (mm)					
			1.1"		1"		2/3"	
H	V	H	V	H	V	H	V	
1000	0.008	-	1790.8	1310.2	1617.6	1206.7	1103.1	820.5
950	0.009	-	1702.4	1245.4	1537.7	1147.0	1048.6	780.0
900	0.009	-	1614.2	1180.9	1458.0	1087.5	994.2	739.5
850	0.010	-	1525.9	1116.2	1378.2	1027.9	939.7	699.0
800	0.010	-	1437.5	1051.4	1298.3	968.3	885.2	658.4
750	0.011	-	1348.8	986.4	1218.0	908.3	830.4	617.6
700	0.012	-	1260.1	921.4	1137.9	848.5	775.7	576.9
650	0.013	-	1172.0	856.8	1058.2	789.0	721.3	536.5
600	0.014	-	1083.5	792.0	978.3	729.3	666.7	495.9
550	0.015	-	995.2	727.3	898.5	669.7	612.2	455.3
500	0.016	-	906.4	662.2	818.2	609.8	557.4	414.6
450	0.018	-	817.8	597.3	738.1	550.0	502.8	373.9
400	0.020	-	729.5	532.6	658.3	490.4	448.3	333.3
350	0.023	-	641.0	467.7	578.3	430.7	393.6	292.7
300	0.027	-	552.1	402.6	497.9	370.6	338.8	251.9
250	0.032	-	463.7	337.9	418.0	311.0	284.3	211.3
200	0.039	-	375.6	273.3	338.4	251.6	229.9	170.9
150	0.051	0.2	287.1	208.5	258.4	191.9	175.3	130.3
100	0.075	0.2	198.5	143.7	178.4	132.2	120.8	89.7

\*There is no filter mount on the top of the lens.  
For using filters, please attach either VM0811 or VM0810.  
For more detail, please refer to P40.

Field of View = CCD Size / Optical Magnification

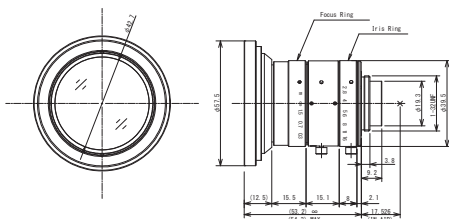





# 1.1" 12 MEGAPIXEL FIXED FOCAL LENS (MPY Series)

1.1" 12MP  
MPY

## V1228-MPY2

- 1.1"
- 12MP
- FIX
- MANUAL
- FLOATING

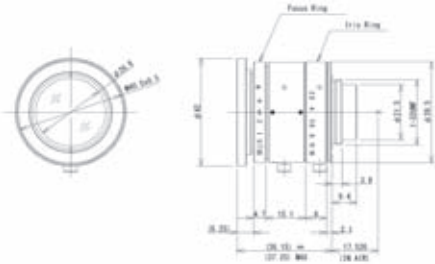

Focal Length	12mm				
Max. Aperture Ratio	1:2.8				
Max. Image Format	14.2mm x 10.4mm ( φ 17.6mm)				
Operation Range	Iris	F2.8 - F16.0			
	Focus	0.3m - Inf.			
Control	Iris	Manual			
	Focus	Manual			
Angle of View	D		71.1°		48.6°
	H	1.1"	60.5°	1"	39.6°
	V		46.2°		30.1°
Operating Temperature	-10°C ~ +50°C				

Optical Distortion	1.1"	-0.5%(y=8.8)	1"	-1.0%(y=8.0)	2/3"	-1.4%(y=5.5)
Back Focal Length	8.4mm					
Flange Back Length	17.526mm					
Mount	C-Mount					
Filter Size	M40.5 P=0.5mm					
Dimensions	φ 42.0mm x 36.1mm					
Weight	97g					

Working Distance (mm)	Optical Magnification	Extension Ring (mm)	Field of View (mm)					
			1.1"		1"		2/3"	
			H	V	H	V	H	V
1000	0.012	-	1167.9	854.2	1053.4	787.5	720.9	538.6
950	0.013	-	1109.5	811.4	1000.7	748.1	684.8	511.6
900	0.014	-	1051.2	768.8	948.2	708.8	648.9	484.8
850	0.015	-	992.9	726.1	895.5	669.4	612.8	457.8
800	0.015	-	934.6	683.4	842.9	630.1	576.8	430.9
750	0.016	-	876.4	640.9	790.4	590.9	540.9	404.1
700	0.018	-	818.0	598.1	737.7	551.5	504.8	377.1
650	0.019	-	759.7	555.5	685.1	512.2	468.8	350.3
600	0.021	-	701.5	512.9	632.7	472.9	432.9	323.4
550	0.022	-	643.0	470.2	579.9	433.5	396.8	296.5
500	0.025	-	584.7	427.5	527.3	394.2	360.8	269.6
450	0.027	-	526.5	384.9	474.8	354.9	324.9	242.7
400	0.031	-	468.2	342.3	422.2	315.6	288.9	215.8
350	0.035	-	409.9	299.7	369.6	276.3	252.9	189.0
300	0.041	-	351.6	257.0	317.0	237.0	216.9	162.1
250	0.048	0.5	303.1	221.0	273.0	203.7	186.4	139.2
200	0.060	0.5	242.7	177.0	218.6	163.1	149.3	111.5
150	0.079	0.5	182.5	133.1	164.3	122.6	112.2	83.8
100	0.115	1.0	126.3	91.9	113.6	84.7	77.5	57.8

Field of View = CCD Size / Optical Magnification

## V1628-MPY2

- 1.1"
- 12MP
- FIX
- MANUAL
- FLOATING

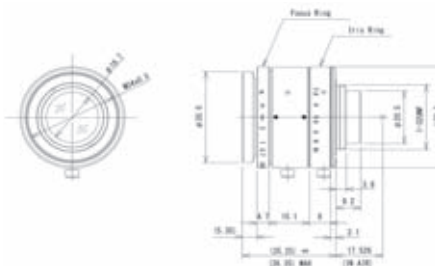

Focal Length	16mm				
Max. Aperture Ratio	1:2.8				
Max. Image Format	14.2mm x 10.4mm ( φ 17.6mm)				
Operation Range	Iris	F2.8 - F16.0			
	Focus	0.3m - Inf.			
Control	Iris	Manual			
	Focus	Manual			
Angle of View	D		57.9°		38.2°
	H	1.1"	48.2°	1"	30.9°
	V		36.2°		23.4°
Operating Temperature	-10°C ~ +50°C				

Optical Distortion	1.1"	-0.5%(y=8.8)	1"	-0.6%(y=8.0)	2/3"	-0.6%(y=5.5)
Back Focal Length	9.4mm					
Flange Back Length	17.526mm					
Mount	C-Mount					
Filter Size	M34.0 P=0.5mm					
Dimensions	φ 39.5mm x 35.2mm					
Weight	89g					

Working Distance (mm)	Optical Magnification	Extension Ring (mm)	Field of View (mm)					
			1.1"		1"		2/3"	
			H	V	H	V	H	V
1000	0.016	-	890.1	651.4	802.4	601.0	550.7	412.4
950	0.017	-	845.4	618.7	762.1	570.9	523.0	391.7
900	0.018	-	800.7	586.0	721.8	540.7	495.4	371.0
850	0.019	-	756.2	553.5	681.7	510.7	467.9	350.5
800	0.020	-	711.5	520.8	641.5	480.5	440.3	329.8
750	0.021	-	666.9	488.1	601.2	450.4	412.7	309.1
700	0.023	-	622.2	455.4	560.9	420.2	385.0	288.4
650	0.025	-	577.4	422.7	520.6	390.0	357.4	267.7
600	0.027	-	532.7	390.0	480.3	359.9	329.7	247.0
550	0.029	-	488.1	357.3	440.0	329.7	302.1	226.3
500	0.032	-	443.4	324.6	399.8	299.6	274.5	205.6
450	0.036	-	398.7	291.9	359.5	269.4	246.9	184.9
400	0.040	-	353.9	259.2	319.2	239.2	219.2	164.2
350	0.046	-	309.3	226.5	278.9	209.1	191.6	143.5
300	0.054	-	264.6	193.8	238.6	178.9	163.9	122.8
250	0.063	1.0	227.8	166.3	205.1	153.3	140.5	105.1
200	0.079	1.0	181.4	132.5	163.4	122.2	111.9	83.8
150	0.106	1.0	135.1	98.8	121.7	91.1	83.5	62.5
100	0.156	2.0	92.1	67.2	82.9	61.9	56.7	42.5

Field of View = CCD Size / Optical Magnification



1.1" 12MP  
MPY

# 1.1" 12 MEGA PIXEL FIXED FOCAL LENS (MPY Series)

- 8, 12, 16, 25, 35, 50mm 6 lens series
- Compatible with 1.1" (φ 17.6mm) large format sensor
- Vibration resistance up to 5G

- Ultra-high resolution 12MP
- Compact 1.1" design (smallest 12MP lens in the industry)

## V2528-MPY

- 1.1"
- 12MP
- FIX
- MANUAL
- FLOATING

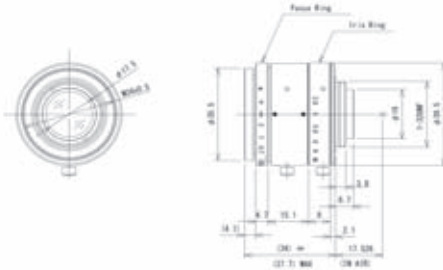

Focal Length	25mm			
Max. Aperture Ratio	1:2.8			
Max. Image Format	14.2mm x 10.4mm (φ 17.6mm)			
Operation Range	Iris	F2.8 - F16.0		
	Focus	0.3m - Inf.		
Control	Iris	Manual		
	Focus	Manual		
Angle of View	D	38.7°	35.4°	24.8°
	H	1.1" 31.7°	1" 28.7°	2/3" 20.0°
	V	23.5°	21.7°	15.0°
Operating Temperature	-10°C ~ +50°C			

Optical Distortion	1.1" 0.3%(y=8.8)	1" 0.2%(y=8.0)	2/3" 0.1%(y=5.5)
Back Focal Length	11.3mm		
Flange Back Length	17.526mm		
Mount	C-Mount		
Filter Size	M34.0 P=0.5mm		
Dimensions	φ 39.5mm x 34mm		
Weight	78g		

Working Distance (mm)	Optical Magnification	Extension Ring (mm)	Field of View (mm)					
			1.1"		1"		2/3"	
			H	V	H	V	H	V
1000	0.026	-	555.5	407.0	500.8	375.7	344.4	258.3
950	0.027	-	527.3	386.3	475.4	356.6	326.9	245.2
900	0.028	-	499.0	365.6	449.9	337.5	309.3	232.0
850	0.030	-	470.7	344.8	424.4	318.3	291.8	218.9
800	0.032	-	442.4	324.1	398.8	299.1	274.2	205.7
750	0.034	-	414.1	303.3	373.3	280.0	256.6	192.5
700	0.037	-	385.7	282.5	347.7	260.8	239.0	179.3
650	0.040	-	357.4	261.7	322.1	241.6	221.5	166.1
600	0.043	-	329.0	240.9	296.6	222.4	203.9	152.9
550	0.047	-	300.7	220.2	271.0	203.2	186.3	139.7
500	0.052	-	272.2	199.3	245.3	184.0	168.6	126.5
450	0.058	-	243.9	178.5	219.8	164.8	151.1	113.3
400	0.066	-	215.5	157.7	194.2	145.6	133.4	100.1
350	0.076	-	187.1	136.9	168.6	126.4	115.8	86.9
300	0.090	-	158.7	116.2	143.0	107.2	98.3	73.7
250	0.108	0.5	131.9	96.5	118.8	89.0	81.6	61.2
200	0.135	1.5	105.6	77.2	95.1	71.3	65.3	48.9
150	0.183	2.5	78.0	57.0	70.3	52.6	48.2	36.1
100	0.281	5.0	50.9	37.2	45.8	34.3	31.4	23.5

Field of View = CCD Size / Optical Magnification

## V3528-MPY

- 1.1"
- 12MP
- FIX
- MANUAL
- FLOATING

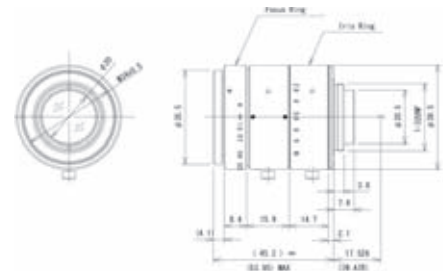

Focal Length	35mm			
Max. Aperture Ratio	1:2.8			
Max. Image Format	14.2mm x 10.4mm (φ 17.6mm)			
Operation Range	Iris	F2.8 - F16.0		
	Focus	0.3m - Inf.		
Control	Iris	Manual		
	Focus	Manual		
Angle of View	D	28.2°	25.8°	17.9°
	H	1.1" 22.9°	1" 20.7°	2/3" 14.3°
	V	16.9°	15.6°	10.8°
Operating Temperature	-10°C ~ +50°C			

Optical Distortion	1.1" -0.1%(y=8.8)	1" 0.0%(y=8.0)	2/3" 0.0%(y=5.5)
Back Focal Length	11.9mm		
Flange Back Length	17.526mm		
Mount	C-Mount		
Filter Size	M34.0 P=0.5mm		
Dimensions	φ 39.5mm x 45.2mm		
Weight	103g		

Working Distance (mm)	Optical Magnification	Extension Ring (mm)	Field of View (mm)					
			1.1"		1"		2/3"	
			H	V	H	V	H	V
1000	0.036	-	393.4	288.2	354.6	266.0	243.9	182.9
950	0.038	-	373.0	273.2	336.2	252.2	231.2	173.4
900	0.040	-	352.7	258.4	317.9	238.5	218.6	164.0
850	0.043	-	332.4	243.5	299.6	224.7	206.0	154.5
800	0.046	-	312.1	228.6	281.3	211.0	193.5	145.1
750	0.049	-	291.8	213.8	263.1	197.3	180.9	135.7
700	0.052	-	271.6	198.9	244.8	183.6	168.3	126.3
650	0.057	-	251.3	184.1	226.5	169.9	155.8	116.8
600	0.061	-	231.0	169.2	208.2	156.2	143.2	107.4
550	0.067	-	210.7	154.3	189.9	142.5	130.6	98.0
500	0.075	-	190.4	139.5	171.6	128.8	118.0	88.6
450	0.083	-	170.1	124.6	153.4	115.1	105.5	79.1
400	0.095	-	149.8	109.8	135.1	101.3	92.9	69.7
350	0.110	-	129.5	94.9	116.8	87.6	80.3	60.3
300	0.130	-	109.3	80.1	98.5	73.9	67.8	50.8
250	0.157	1.5	90.4	66.2	81.5	61.1	56.0	42.0
200	0.201	3.0	70.9	51.9	63.9	47.9	43.9	32.9
150	0.277	6.0	51.6	37.7	46.5	34.8	31.9	23.9
100	0.435	15.0	32.9	24.0	29.6	22.2	20.3	15.2

Field of View = CCD Size / Optical Magnification



# 1.1" 12 MEGAPIXEL FIXED FOCAL LENS (MPY Series)

1.1" 12MP  
MPY

## V5028-MPY

- 1.1"
- 12MP
- FIX
- MANUAL
- FLOATING



Focal Length	50mm				
Max. Aperture Ratio	1:2.8				
Max. Image Format	14.2mm x 10.4mm (φ 17.6mm)				
Operation Range	Iris	F2.8 - F16.0			
	Focus	0.5m - Inf.			
Control	Iris	Manual			
	Focus	Manual			
Angle of View	D	20.0°	18.2°	12.6°	
	H	1.1" 16.2°	1" 14.6°	2/3" 10.1°	
	V	11.9°	11.0°	7.6°	
Operating Temperature	-10° C ~ +50° C				

Optical Distortion	1.1" 0.1% (γ=8.8)	1" 0.1% (γ=8.0)	2/3" 0.1% (γ=5.5)
Back Focal Length	11.9mm		
Flange Back Length	17.526mm		
Mount	C-Mount		
Filter Size	M34.0 P=0.5mm		
Dimensions	φ 39.5mm x 45.1mm		
Weight	107g		

Working Distance (mm)	Optical Magnification	Extension Ring (mm)	Field of View (mm)					
			1.1"		1"		2/3"	
			H	V	H	V	H	V
1000	0.055	-	257.9	188.9	232.5	174.4	159.8	119.9
950	0.058	-	243.7	178.5	219.7	164.7	151.0	113.3
900	0.062	-	229.5	168.1	206.9	155.1	142.2	106.7
850	0.066	-	215.3	157.6	194.0	145.5	133.4	100.0
800	0.071	-	201.1	147.2	181.2	135.9	124.6	93.4
750	0.076	-	186.9	136.8	168.4	126.3	115.8	86.8
700	0.082	-	172.7	126.4	155.6	116.7	107.0	80.2
650	0.090	-	158.5	116.0	142.8	107.1	98.2	73.6
600	0.099	-	144.2	105.6	130.0	97.5	89.4	67.0
550	0.109	-	130.0	95.2	117.2	87.9	80.6	60.4
500	0.123	-	115.9	84.8	104.4	78.3	71.8	53.8
450	0.138	1.0	103.1	75.4	92.9	69.6	63.8	47.9
400	0.158	2.0	89.9	65.8	81.0	60.7	55.7	41.7
350	0.181	5.0	78.5	57.4	70.7	53.0	48.6	36.4
300	0.222	6.0	64.2	47.0	57.8	43.3	39.7	29.8
250	0.276	10.0	51.7	37.8	46.6	34.9	32.0	24.0
200	0.373	15.0	38.2	27.9	34.4	25.8	23.6	17.7
150	0.583	25.0	24.5	17.9	22.1	16.5	15.1	11.3
100	1.255	61.5	11.3	8.3	10.2	7.7	7.0	5.3

Field of View = CCD Size / Optical Magnification

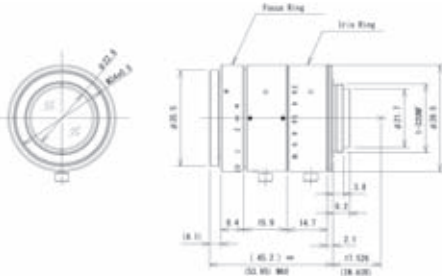

### FLOATING

Basically, lens is designed to show the best performance at a certain working distance. Due to this design, a curvature of field\* is caused at other working distances, and the picture deteriorates at the corners. This curvature of field is able to be modified by a method called Floating, which makes several lens element groups move differently and controls aberration. It can provide stable picture quality from short object distances to infinity.

\*Curvature of field: Phenomenon caused by the gap of the focal point between center and corner

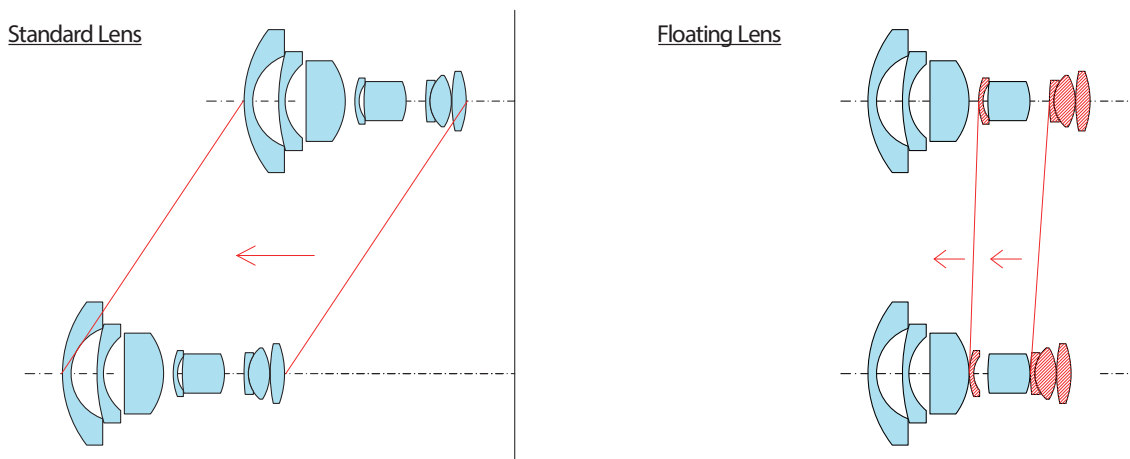



2/3" 6MP  
MPW3



- ✓ Suitable for 2/3" 6 megapixel
- ✓ A variety of focal lengths from 5mm to 75mm
- ✓ Maintains high performance at long WD
- ✓ An ultra-compact Ø29 diameter with a nearly identical mechanical length
- ✓ Vibration resistance up to 5G

# MPW3 Series

2/3" 6 MEGAPIXEL Machine Vision Lens

Model No.	Format	Focal Length	F No.	Working Distance	Weight
M0528-MPW3	2/3"	5mm	F2.8-F16	0.1m-Inf.	TBD
M0828-MPW3		8mm		0.1m-Inf.	58g
M1228-MPW3		12mm		0.1m-Inf.	60g
M1628-MPW3		16mm		0.25m-Inf.	37g
M2528-MPW3		25mm		0.2m-Inf.	42g
M3528-MPW3		35mm		0.25m-Inf.	48g
M5028-MPW3		50mm		0.3m-Inf.	65g
M7528-MPW3		75mm		0.4m-Inf.	102g

## NEW M1628-MPW3 MTF WD300mm

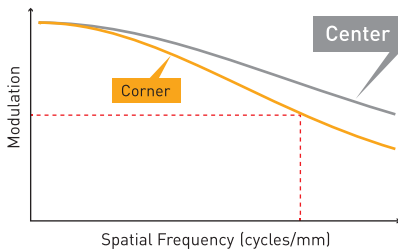

## Conventional Product MTF WD300mm

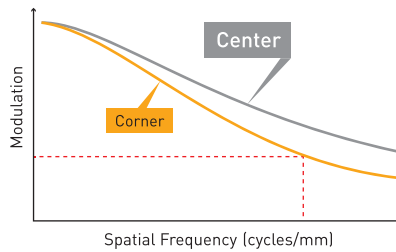

## Relative Illumination

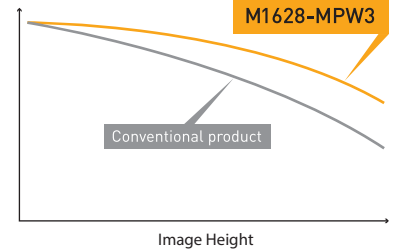

NEW

## M0528-MPW3

- 2/3"
- 6MP
- FIX
- MANUAL
- WIDE

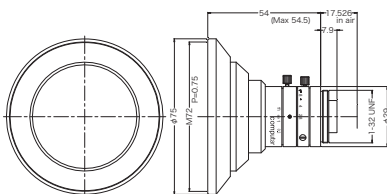

Focal Length	5mm				
Max. Aperture Ratio	1:2.8				
Max. Image Format	8.8mm x 6.6mm (φ 11mm)				
Operation Range	Iris	F2.8 - F16.0			
	Focus	0.1m - Inf.			
Control	Iris	Manual			
	Focus	Manual			
Angle of View	D		94.6°	83.8°	71.4°
	H	2/3"	83.2°	1/1.8"	71.6°
	V		67.5°	58.3°	46.6°
Operating Temperature	-10°C ~ +50°C				

Optical Distortion	2/3"	0.03%(y=5.5)	1/1.8"	-2.14%(y=4.5)	1/2.5"	-2.72%(y=3.55)
Back Focal Length	9.2mm					
Flange Back Length	17.526mm					
Mount	C-Mount					
Filter Size	M72 P=0.75mm					
Dimensions	φ 75mm x 54mm					
Weight	TBD					

Working Distance (mm)	Optical Magnification	Extension Ring (mm)	Field of View (mm)					
			2/3"		1/1.8"		1/2.5"	
			H	V	H	V	H	V
1000	0.005	-	1811.6	1361.5	1487.1	1108.3	1171.7	876.9
950	0.005	-	1723.0	1294.8	1414.3	1053.9	1114.2	833.9
900	0.006	-	1634.3	1228.1	1341.4	999.6	1056.8	790.8
850	0.006	-	1545.7	1161.4	1268.5	945.2	999.3	747.8
800	0.006	-	1457.0	1094.6	1195.7	890.9	941.9	704.8
750	0.007	-	1368.4	1027.9	1122.8	836.5	884.4	661.8
700	0.007	-	1279.8	961.2	1050.0	782.2	827.0	618.8
650	0.008	-	1191.1	894.4	977.1	727.9	769.5	575.8
600	0.008	-	1102.5	827.7	904.2	673.5	712.1	532.8
550	0.009	-	1013.8	761.0	831.4	619.2	654.6	489.8
500	0.010	-	925.2	694.2	758.5	564.8	597.2	446.7
450	0.011	-	836.6	627.5	685.7	510.5	539.7	403.7
400	0.012	-	747.9	560.8	612.8	456.1	482.3	360.7
350	0.014	-	659.3	494.0	539.9	401.8	424.8	317.7
300	0.016	-	570.6	427.3	467.1	347.4	367.4	274.7
250	0.019	-	482.0	360.6	394.2	293.1	309.9	231.7
200	0.023	-	393.3	293.8	321.3	238.7	252.5	188.7
150	0.030	-	304.7	227.1	248.5	184.4	195.0	145.7
100	0.043	-	216.0	160.4	175.6	130.0	137.6	102.6

Field of View = CCD Size / Optical Magnification



# 2/3" 6 MEGAPIXEL FIXED FOCAL LENS (MPW3 Series)

2/3" 6MP  
MPW3

**NEW**

## M0828-MPW3

- 2/3"
- 6MP
- FIX
- MANUAL

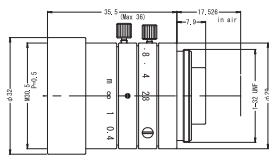
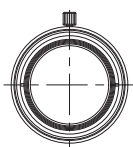

Focal Length	8mm				
Max. Aperture Ratio	1:2.8				
Max. Image Format	8.8mm x 6.6mm ( φ 11mm)				
Operation Range	Iris	F2.8 - F16.0			
	Focus	0.1m - Inf.			
Control	Iris	Manual			
	Focus	Manual			
Angle of View	D	68.5°	57.7°	47.2°	
	H	2/3" 57.0°	1/1.8" 47.3°	1/2.5" 38.5°	
	V	44.2°	37.5°	29.4°	
Operating Temperature	-10°C ~ +50°C				

Optical Distortion	2/3"	-1.80%(γ=-5.5)	1/1.8"	-1.68%(γ=-4.5)	1/2.5"	-1.28%(γ=-3.55)
Back Focal Length	10.1mm					
Flange Back Length	17.526mm					
Mount	C-Mount					
Filter Size	M30.5 P=0.5mm					
Dimensions	φ 32mm x 35.5mm					
Weight	58g					

Working Distance (mm)	Optical Magnification	Extension Ring (mm)	Field of View (mm)					
			2/3"		1/1.8"		1/2.5"	
			H	V	H	V	H	V
1000	0.008	-	1099.4	820.0	896.0	668.7	706.4	530.9
950	0.009	-	1045.2	779.5	851.8	635.6	671.5	504.7
900	0.009	-	990.8	739.0	807.5	602.6	636.6	478.4
850	0.010	-	936.6	698.5	763.3	569.5	601.7	452.2
800	0.010	-	882.2	657.9	719.0	536.5	566.8	425.9
750	0.011	-	828.0	617.5	674.8	503.5	531.9	399.7
700	0.012	-	773.7	576.9	630.4	470.4	497.0	373.5
650	0.013	-	719.4	536.4	586.2	437.4	462.1	347.2
600	0.014	-	665.1	495.9	541.9	404.3	427.1	321.0
550	0.015	-	610.9	455.4	497.7	371.3	392.3	294.8
500	0.016	-	556.5	414.9	453.4	338.2	357.3	268.5
450	0.018	-	502.3	374.4	409.2	305.2	322.4	242.3
400	0.020	-	448.0	333.9	364.9	272.2	287.6	216.1
350	0.023	-	393.7	293.3	320.6	239.1	252.6	189.8
300	0.027	-	339.4	252.8	276.3	206.0	217.7	163.5
250	0.032	-	285.1	212.3	232.1	173.0	182.8	137.3
200	0.039	-	230.8	171.8	187.8	139.9	147.9	111.1
150	0.051	-	176.5	131.3	143.5	106.9	113.0	84.8
100	0.074	-	122.2	90.7	99.3	73.9	78.1	58.6

Field of View = CCD Size / Optical Magnification

**NEW**

## M1228-MPW3

- 2/3"
- 6MP
- FIX
- MANUAL

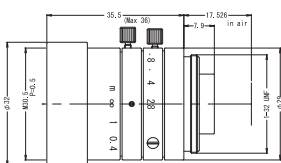

Focal Length	12mm				
Max. Aperture Ratio	1:2.8				
Max. Image Format	8.8mm x 6.6mm ( φ 11mm)				
Operation Range	Iris	F2.8 - F16.0			
	Focus	0.1m - Inf.			
Control	Iris	Manual			
	Focus	Manual			
Angle of View	D	49.3°	40.8°	33.0°	
	H	2/3" 40.3°	1/1.8" 33.1°	1/2.5" 26.7°	
	V	30.8°	26.0°	20.3°	
Operating Temperature	-10°C ~ +50°C				

Optical Distortion	2/3"	-0.10%(γ=-5.5)	1/1.8"	0.04%(γ=-4.5)	1/2.5"	0.00%(γ=-3.55)
Back Focal Length	9.2mm					
Flange Back Length	17.526mm					
Mount	C-Mount					
Filter Size	M27 P=0.5mm					
Dimensions	φ 29mm x 43.5mm					
Weight	60g					

Working Distance (mm)	Optical Magnification	Extension Ring (mm)	Field of View (mm)					
			2/3"		1/1.8"		1/2.5"	
			H	V	H	V	H	V
1000	0.012	-	743.1	557.3	607.9	455.9	481.3	363.0
950	0.012	-	706.4	529.8	577.9	433.4	457.5	345.1
900	0.013	-	669.7	502.3	547.9	410.9	433.7	327.1
850	0.014	-	633.1	474.7	517.9	388.4	410.0	309.2
800	0.015	-	596.4	447.2	487.9	365.9	386.2	291.3
750	0.016	-	559.8	419.7	457.9	343.3	362.4	273.3
700	0.017	-	523.1	392.2	427.9	320.8	338.7	255.4
650	0.018	-	486.4	364.7	397.9	298.3	314.9	237.5
600	0.020	-	449.8	337.2	367.9	275.8	291.1	219.6
550	0.021	-	413.1	309.7	337.8	253.3	267.4	201.6
500	0.023	-	376.4	282.1	307.8	230.8	243.6	183.7
450	0.026	-	339.8	254.6	277.8	208.3	219.8	165.8
400	0.029	-	303.1	227.1	247.8	185.7	196.1	147.8
350	0.033	-	266.4	199.6	217.8	163.2	172.3	129.9
300	0.038	-	229.7	172.1	187.8	140.7	148.6	112.0
250	0.046	-	193.1	144.6	157.8	118.2	124.8	94.1
200	0.057	-	156.4	117.1	127.8	95.7	101.0	76.1
150	0.074	-	119.7	89.5	97.7	73.2	77.3	58.2
100	0.107	-	83.0	62.0	67.7	50.6	53.5	40.3

Field of View = CCD Size / Optical Magnification



2/3" 6MP  
MPW3

## 2/3" 6 MEGAPIXEL FIXED FOCAL LENS (MPW3 Series)

- Suitable for 2/3" 6 megapixel
- 5, 8, 12, 16, 25, 35, 50, 75mm 8 lens series
- Vibration resistance up to 5G

- Maintains high performance at long WD
- An ultra-compact Ø29 diameter with a nearly identical mechanical length

**NEW**

### M1628-MPW3

2/3"  
6MP  
FIX  
MANUAL

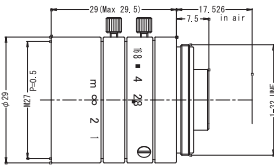
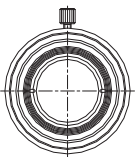

Focal Length	16mm			
Max. Aperture Ratio	1:2.8			
Max. Image Format	8.8mm x 6.6mm ( φ 11mm)			
Operation Range	Iris F2.8 - F16.0			
	Focus 0.25m - Inf.			
Control	Iris Manual			
	Focus Manual			
Angle of View	D	37.8°	31.4°	25.0°
	H	2/3" 30.7°	1/1.8" 25.3°	1/2.5" 20.2°
	V	23.3°	19.2°	15.3°
Operating Temperature	-10°C ~ +50°C			

Optical Distortion	2/3"	0.47%(γ=5.5)	1/1.8"	0.19%(γ=4.5)	1/2.5"	0.03%(γ=3.55)
Back Focal Length	10.3mm					
Flange Back Length	17.526mm					
Mount	C-Mount					
Filter Size	M27 P=0.5mm					
Dimensions	φ 29mm x 29mm					
Weight	37g					

Working Distance (mm)	Optical Magnification	Extension Ring (mm)	Field of View (mm)					
			2/3"		1/1.8"		1/2.5"	
			H	V	H	V	H	V
1000	0.016	-	552.5	414.6	452.3	339.2	358.1	270.1
950	0.017	-	525.0	394.0	429.8	322.3	340.3	256.7
900	0.018	-	497.6	373.4	407.3	305.5	322.5	243.2
850	0.019	-	470.1	352.8	384.8	288.6	304.7	229.8
800	0.020	-	442.7	332.1	362.3	271.7	286.8	216.4
750	0.021	-	415.2	311.5	339.8	254.9	269.0	202.9
700	0.023	-	387.7	290.9	317.4	238.0	251.2	189.5
650	0.024	-	360.3	270.3	294.9	221.1	233.4	176.1
600	0.026	-	332.8	249.7	272.4	204.3	215.6	162.6
550	0.029	-	305.4	229.1	249.9	187.4	197.8	149.2
500	0.032	-	277.9	208.5	227.4	170.5	180.0	135.8
450	0.035	-	250.5	187.8	204.9	153.6	162.2	122.3
400	0.040	-	223.0	167.2	182.5	136.8	144.4	108.9
350	0.045	-	195.5	146.6	160.0	119.9	126.6	95.4
300	0.052	-	168.1	126.0	137.5	103.0	108.8	82.0
250	0.063	-	140.6	105.4	115.0	86.2	91.0	68.6
200	0.078	0.3	113.2	84.8	92.5	69.3	73.2	55.1
150	0.103	0.6	85.7	64.1	70.0	52.4	55.3	41.7
100	0.153	1.5	58.2	43.5	47.5	35.5	37.5	28.3

Field of View = CCD Size / Optical Magnification

**NEW**

### M2528-MPW3

2/3"  
6MP  
FIX  
MANUAL

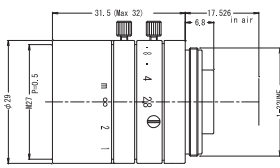
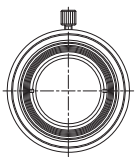

Focal Length	25mm			
Max. Aperture Ratio	1:2.8			
Max. Image Format	8.8mm x 6.6mm ( φ 11mm)			
Operation Range	Iris F2.8 - F16.0			
	Focus 0.2m - Inf.			
Control	Iris Manual			
	Focus Manual			
Angle of View	D	24.6°	20.3°	16.1°
	H	2/3" 19.9°	1/1.8" 16.3°	1/2.5" 13.0°
	V	15.0°	12.3°	9.8°
Operating Temperature	-10°C ~ +50°C			

Optical Distortion	2/3"	0.77%(γ=5.5)	1/1.8"	0.49%(γ=4.5)	1/2.5"	0.29%(γ=3.55)
Back Focal Length	11.5mm					
Flange Back Length	17.526mm					
Mount	C-Mount					
Filter Size	M27 P=0.5mm					
Dimensions	φ 29mm x 31.5mm					
Weight	42g					

Working Distance (mm)	Optical Magnification	Extension Ring (mm)	Field of View (mm)					
			2/3"		1/1.8"		1/2.5"	
			H	V	H	V	H	V
1000	0.025	-	351.1	263.7	287.6	215.9	227.8	171.9
950	0.026	-	333.6	250.5	273.2	205.1	216.4	163.4
900	0.028	-	316.1	237.3	258.8	194.3	205.1	154.8
850	0.029	-	298.6	224.2	244.5	183.5	193.7	146.2
800	0.031	-	281.0	211.0	230.1	172.7	182.3	137.6
750	0.033	-	263.5	197.8	215.8	161.9	170.9	129.0
700	0.036	-	246.0	184.7	201.4	151.2	159.5	120.4
650	0.038	-	228.5	171.5	187.1	140.4	148.2	111.8
600	0.042	-	210.9	158.3	172.7	129.6	136.8	103.2
550	0.045	-	193.4	145.2	158.3	118.8	125.4	94.6
500	0.050	-	175.9	132.0	144.0	108.0	114.0	86.0
450	0.056	-	158.4	118.8	129.6	97.2	102.6	77.4
400	0.062	-	140.8	105.7	115.3	86.5	91.3	68.9
350	0.071	-	123.3	92.5	100.9	75.7	79.9	60.3
300	0.083	-	105.8	79.3	86.5	64.9	68.5	51.7
250	0.100	-	88.2	66.1	72.2	54.1	57.1	43.1
200	0.125	-	70.7	53.0	57.8	43.3	45.7	34.5
150	0.166	1.0	53.1	39.8	43.4	32.5	34.3	25.9
100	0.249	3.0	35.6	26.6	29.0	21.7	22.9	17.3

Field of View = CCD Size / Optical Magnification



# 2/3" 6 MEGAPIXEL FIXED FOCAL LENS (MPW3 Series)

2/3" 6MP  
MPW3

**NEW**

## M3528-MPW3

2/3"

6MP

FIX

MANUAL

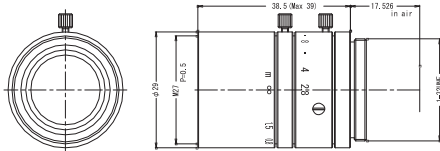

Focal Length	35mm				
Max. Aperture Ratio	1:2.8				
Max. Image Format	8.8mm x 6.6mm ( φ 11mm)				
Operation Range	Iris	F2.8 - F16.0			
	Focus	0.25m - Inf.			
Control	Iris	Manual			
	Focus	Manual			
Angle of View	D	17.9°	14.4°	9.8°	
	H	2/3" 14.3°	1/1.8" 11.7°	1/2.5" 7.8°	
	V	10.8°	8.7°	5.9°	
Operating Temperature	-10°C ~ +50°C				

Optical Distortion	2/3"	0.06%(y=5.5)	1/1.8"	0.04%(y=4.5)	1/2.5"	0.03%(y=3.5)
Back Focal Length	18.0mm					
Flange Back Length	17.526mm					
Mount	C-Mount					
Filter Size	M27 P=0.5mm					
Dimensions	φ 29mm x 38.5mm					
Weight	48g					

Working Distance (mm)	Optical Magnification	Extension Ring (mm)	Field of View (mm)					
			2/3"		1/1.8"		1/2.5"	
			H	V	H	V	H	V
1000	0.036	-	247.9	185.9	202.8	152.1	160.5	121.1
950	0.037	-	235.3	176.5	192.5	144.4	152.4	115.0
900	0.040	-	222.8	167.1	182.3	136.7	144.3	108.8
850	0.042	-	210.2	157.6	172.0	129.0	136.1	102.7
800	0.045	-	197.6	148.2	161.7	121.2	128.0	96.5
750	0.048	-	185.1	138.8	151.4	113.5	119.8	90.4
700	0.051	-	172.5	129.3	141.1	105.8	111.7	84.3
650	0.055	-	159.9	119.9	130.8	98.1	103.5	78.1
600	0.060	-	147.3	110.5	120.5	90.4	95.4	72.0
550	0.065	-	134.8	101.0	110.2	82.7	87.3	65.8
500	0.072	-	122.2	91.6	100.0	74.9	79.1	59.7
450	0.080	-	109.6	82.2	89.7	67.2	71.0	53.5
400	0.091	-	97.0	72.8	79.4	59.5	62.8	47.4
350	0.104	-	84.5	63.3	69.1	51.8	54.7	41.3
300	0.123	-	71.9	53.9	58.8	44.1	46.5	35.1
250	0.149	-	59.3	44.5	48.5	36.4	38.4	29.0
200	0.189	1.5	46.7	35.0	38.2	28.6	30.2	22.8
150	0.259	4.0	34.1	25.6	27.9	20.9	22.1	16.6
100	0.412	9.5	21.5	16.1	17.6	13.2	13.9	10.5

Field of View = CCD Size / Optical Magnification

**NEW**

## M5028-MPW3

2/3"

6MP

FIX

MANUAL

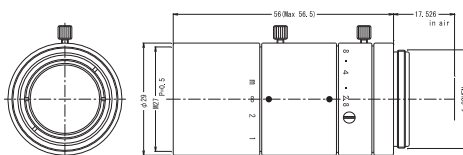

Focal Length	50mm				
Max. Aperture Ratio	1:2.8				
Max. Image Format	8.8mm x 6.6mm ( φ 11mm)				
Operation Range	Iris	F2.8 - F16.0			
	Focus	0.3m - Inf.			
Control	Iris	Manual			
	Focus	Manual			
Angle of View	D	12.5°	10.2°	8.1°	
	H	2/3" 10.0°	1/1.8" 8.2°	1/2.5" 6.5°	
	V	7.5°	6.2°	4.9°	
Operating Temperature	-10°C ~ +50°C				

Optical Distortion	2/3"	0.00%(y=5.5)	1/1.8"	0.00%(y=4.5)	1/2.5"	0.00%(y=3.5)
Back Focal Length	26.3mm					
Flange Back Length	17.526mm					
Mount	C-Mount					
Filter Size	M27 P=0.5mm					
Dimensions	φ 29mm x 56mm					
Weight	65g					

Working Distance (mm)	Optical Magnification	Extension Ring (mm)	Field of View (mm)					
			2/3"		1/1.8"		1/2.5"	
			H	V	H	V	H	V
1000	0.052	-	168.9	126.8	138.3	103.7	109.5	82.6
950	0.055	-	160.2	120.2	131.1	98.4	103.8	78.3
900	0.058	-	151.4	113.6	123.9	93.0	98.1	74.0
850	0.062	-	142.6	107.0	116.7	87.6	92.4	69.8
800	0.066	-	133.8	100.4	109.6	82.2	86.8	65.5
750	0.070	-	125.1	93.9	102.4	76.8	81.1	61.2
700	0.075	-	116.3	87.3	95.2	71.4	75.4	56.9
650	0.082	-	107.5	80.7	88.0	66.0	69.7	52.6
600	0.089	-	98.8	74.1	80.8	60.6	64.0	48.3
550	0.098	-	90.0	67.5	73.6	55.3	58.3	44.0
500	0.108	-	81.2	60.9	66.5	49.9	52.6	39.7
450	0.121	-	72.4	54.3	59.3	44.5	46.9	35.4
400	0.138	-	63.7	47.8	52.1	39.1	41.3	31.1
350	0.160	-	54.9	41.2	44.9	33.7	35.6	26.8
300	0.191	-	46.1	34.6	37.7	28.3	29.9	22.5
250	0.236	2.2	37.3	28.0	30.5	22.9	24.2	18.2
200	0.308	6.0	28.5	21.4	23.4	17.5	18.5	14.0
150	0.445	13.0	19.8	14.8	16.2	12.1	12.8	9.7
100	0.802	30.5	11.0	8.2	9.0	6.7	7.1	5.4

Field of View = CCD Size / Optical Magnification



2/3" 6MP  
MPW3

## 2/3" 6 MEGAPIXEL FIXED FOCAL LENS (MPW3 Series)

- Suitable for 2/3" 6 megapixel
- 5, 8, 12, 16, 25, 35, 50, 75mm 8 lens series
- Vibration resistance up to 5G

- Maintains high performance at long WD
- An ultra-compact Ø29 diameter with a nearly identical mechanical length

**NEW**

### M7528-MPW3

- 2/3"
- 6MP
- FIX
- MANUAL
- TELE

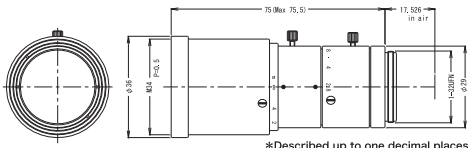

Focal Length	75mm					
Max. Aperture Ratio	1:2.8					
Max. Image Format	8.8mm x 6.6mm ( $\phi$ 11mm)					
Operation Range	Iris	F2.8 - F16.0				
	Focus	0.4m - Inf.				
Control	Iris	Manual				
	Focus	Manual				
Angle of View	D	8.4°	6.9°	5.4°		
	H	2/3" 6.7°	1/1.8" 5.5°	1/2.5" 4.3°		
	V	5.0°	4.1°	3.3°		
Operating Temperature	-10°C ~ +50°C					

Optical Distortion	2/3"	0.33%(y)=5.5)	1/1.8"	0.21%(y)=4.5)	1/2.5"	0.12%(y)=3.55)
Back Focal Length	14.6mm					
Flange Back Length	17.526mm					
Mount	C-Mount					
Filter Size	M34 P=0.5mm					
Dimensions	$\phi$ 36mm x 75mm					
Weight	102g					

Working Distance (mm)	Optical Magnification	Extension Ring (mm)	Field of View (mm)					
			2/3"		1/1.8"		1/2.5"	
			H	V	H	V	H	V
1000	0.071	-	123.1	92.3	100.7	75.5	79.7	60.1
950	0.075	-	117.2	87.9	95.9	71.9	75.9	57.3
900	0.079	-	111.4	83.5	91.1	68.3	72.1	54.4
850	0.083	-	105.5	79.1	86.3	64.7	68.3	51.5
800	0.088	-	99.7	74.7	81.5	61.1	64.5	48.7
750	0.094	-	93.8	70.3	76.7	57.5	60.7	45.8
700	0.100	-	87.9	65.9	71.9	53.9	56.9	43.0
650	0.107	-	82.1	61.5	67.1	50.3	53.1	40.1
600	0.116	-	76.2	57.1	62.4	46.7	49.3	37.2
550	0.125	-	70.4	52.8	57.6	43.2	45.6	34.4
500	0.137	-	64.5	48.4	52.8	39.6	41.8	31.5
450	0.150	-	58.7	44.0	48.0	36.0	38.0	28.6
400	0.167	-	52.8	39.6	43.2	32.4	34.2	25.8
350	0.188	1.5	46.9	35.2	38.4	28.8	30.4	22.9
300	0.215	3.5	41.1	30.8	33.6	25.2	26.6	20.0
250	0.251	6.0	35.2	26.4	28.8	21.6	22.8	17.2
200	0.301	10.0	29.3	22.0	24.0	18.0	19.0	14.3
150	0.377	16.0	23.5	17.6	19.2	14.4	15.2	11.4
100	0.503	25.0	17.6	13.2	14.4	10.8	11.4	8.6

Field of View = CCD Size / Optical Magnification





# 2/3" 5 MEGAPIXEL FIXED FOCAL LENS (MPW2 Series)

2/3" 5MP  
MPW2

- Ultra-low distortion (optical distortion 0.1% or less)
- High relative illumination rate

- Compact design
- Locking set screws for focus and iris

## M0824-MPW2

- 2/3"
- 5MP
- FIX
- MANUAL



Focal Length	8mm			
Max. Aperture Ratio	1:2.4			
Max. Image Format	8.8mm x 6.6mm (φ 11mm)			
Operation Range	Iris	F2.4 - F16.0		
	Focus	0.05m - Inf.		
Control	Iris	Manual		
	Focus	Manual		
Angle of View	D	69.32°	56.90°	53.23°
	H	2/3" 57.80°	1/1.8" 46.72°	1/2" 43.74°
	V	44.36°	35.75°	33.23°
Operating Temperature	-10° C ~ +50° C			

Optical Distortion	2/3"	1.87%(y=5.5)	1/1.8"	-1.55%(y=4.32)	1/2"	-1.42%(y=4.0)
Back Focal Length	13.7mm(WD=300mm)					
Flange Back Length	17.526mm					
Mount	C-Mount					
Filter Size	M30.5 P=0.5mm					
Dimensions	φ 32mm x 45.71mm					
Weight	80g					



Working Distance (mm)	Optical Magnification	Extension Ring (mm)	Field of View (mm)					
			2/3"		1/1.8"		1/2"	
			H	V	H	V	H	V
900	0.009	-	1011.1	755.4	791.6	591.5	732.2	547.3
850	0.009	-	956.0	714.2	748.5	559.3	692.3	517.4
800	0.010	-	900.9	673.0	705.3	527.0	652.3	487.6
750	0.011	-	845.8	631.8	662.1	494.7	612.4	457.7
700	0.011	-	790.7	590.6	618.9	462.5	572.5	427.8
650	0.012	-	735.6	549.4	575.8	430.2	532.5	398.0
600	0.013	-	680.4	508.2	532.6	397.9	492.6	368.1
550	0.014	-	625.3	467.0	489.4	365.6	452.6	338.3
500	0.016	-	570.0	425.6	446.0	333.2	412.6	308.2
450	0.017	-	515.0	384.4	403.0	301.0	372.6	278.4
400	0.019	-	459.8	343.2	359.8	268.8	332.6	248.6
350	0.022	-	404.6	302.0	316.6	236.4	292.8	218.8
300	0.026	-	349.6	260.8	273.4	204.2	252.8	188.8
250	0.030	-	294.4	219.6	230.2	171.8	212.8	159.0
200	0.037	-	239.4	178.4	187.0	139.6	173.0	129.2
150	0.049	-	184.2	137.2	143.8	107.4	133.0	99.2
100	0.070	-	129.0	96.0	100.6	75.0	93.0	69.4
50	0.127	-	71.4	52.9	55.5	41.3	51.3	38.2

Field of View = CCD Size / Optical Magnification

## M1224-MPW2

- 2/3"
- 5MP
- FIX
- MANUAL



Focal Length	12mm			
Max. Aperture Ratio	1:2.4			
Max. Image Format	8.8mm x 6.6mm (φ 11mm)			
Operation Range	Iris	F2.4 - F16.0		
	Focus	0.1m - Inf.		
Control	Iris	Manual		
	Focus	Manual		
Angle of View	D	48.6°	39.1°	36.5°
	H	2/3" 39.8°	1/1.8" 31.7°	1/2" 29.5°
	V	30.4°	24.0°	22.3°
Operating Temperature	-10° C ~ +50° C			

Optical Distortion	2/3"	-0.05%(y=5.5)	1/1.8"	-0.34%(y=4.32)	1/2"	-0.35%(y=4.0)
Back Focal Length	14.4mm(WD=300mm)					
Flange Back Length	17.526mm					
Mount	C-Mount					
Filter Size	M27.0 P=0.5mm					
Dimensions	φ 29mm x 42.68mm					
Weight	72g					



Working Distance (mm)	Optical Magnification	Extension Ring (mm)	Field of View (mm)					
			2/3"		1/1.8"		1/2"	
			H	V	H	V	H	V
900	0.0131	-	671.2	503.7	527.5	395.5	488.4	366.1
850	0.0138	-	634.6	476.2	498.7	373.9	461.8	346.1
800	0.0147	-	598.0	448.7	469.9	352.3	435.1	326.1
750	0.0157	-	561.4	421.2	441.1	330.7	408.4	306.1
700	0.016	-	524.7	393.7	412.3	309.1	381.8	286.1
650	0.018	-	488.1	366.2	383.5	287.5	355.1	266.1
600	0.019	-	451.5	338.7	354.7	265.9	328.4	246.1
550	0.021	-	414.8	311.2	325.9	244.3	301.7	226.1
500	0.022	-	378.2	283.7	297.2	222.7	275.1	206.2
450	0.026	-	341.6	256.2	268.4	201.1	248.4	186.2
400	0.029	-	305.0	228.7	239.6	179.5	221.8	166.2
350	0.033	-	268.3	201.2	210.8	157.9	195.1	146.2
300	0.038	-	231.7	173.7	182.0	136.3	168.4	126.2
250	0.045	-	195.1	146.2	153.2	114.7	141.8	106.2
200	0.056	-	158.5	118.7	124.4	93.1	115.1	86.2
150	0.073	-	121.8	91.2	95.6	71.5	88.4	66.2
100	0.104	-	85.2	63.7	66.8	50.0	61.8	46.2

Field of View = CCD Size / Optical Magnification

2/3" 5MP  
MPW2

## 2/3" 5 MEGAPIXEL FIXED FOCAL LENS (MPW2 Series)



- Ultra-low distortion (optical distortion 0.1% or less)
- High relative illumination rate

- Compact design
- Locking set screws for focus and iris

### M1620-MPW2

- 2/3"
- 5MP
- FIX
- MANUAL

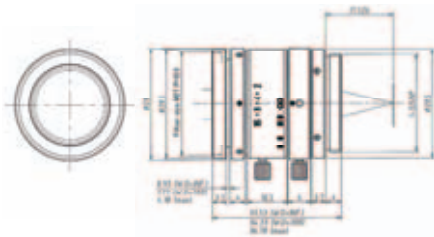

Focal Length	16mm				
Max. Aperture Ratio	1:2.0				
Max. Image Format	8.8mm x 6.6mm (φ 11mm)				
Operation Range	Iris	F2.0 - F16.0			
	Focus	0.2m - Inf.			
Control	Iris	Manual			
	Focus	Manual			
Angle of View	D	37.7°	30.1°	28.0°	
	H	2/3" 30.7°	1/1.8" 24.3°	1/2" 22.6°	
	V	23.3°	18.5°	17.1°	
Operating Temperature	-10°C ~ +50°C				

Optical Distortion	2/3"	0.09%(y=5.5)	1/1.8"	-0.06%(y=4.32)	1/2"	-0.07%(y=4.0)
BackFocalLength	14.7mm (WD=300mm)					
Flange Back Length	17.526mm					
Mount	C-Mount					
Filter Size	M27.0 P=0.5mm					
Dimensions	φ 29mm x 33.53mm					
Weight	53g					

Working Distance (mm)	Optical Magnification	Extension Ring (mm)	Field of View (mm)					
			2/3"		1/1.8"		1/2"	
			H	V	H	V	H	V
900	0.018	-	501.2	376.4	393.5	296.7	365.0	273.9
850	0.019	-	473.8	355.8	372.0	280.5	345.1	258.9
800	0.020	-	446.4	335.2	350.4	264.2	325.1	243.9
750	0.021	-	418.9	314.6	328.9	248.0	305.1	228.9
700	0.022	-	391.5	294.0	307.4	231.7	285.1	213.9
650	0.024	-	364.1	273.4	285.8	215.5	265.2	198.9
600	0.026	-	336.7	252.8	264.3	199.3	245.2	183.9
550	0.028	-	309.3	232.2	242.8	183.0	225.2	168.9
500	0.031	-	281.9	211.6	221.2	166.8	205.2	153.9
450	0.035	-	254.5	191.0	199.7	150.5	185.2	138.9
400	0.039	-	227.1	170.4	178.2	134.3	165.3	124.0
350	0.044	-	199.7	149.8	156.6	118.0	145.3	109.0
300	0.0511	-	172.2	129.2	135.1	101.8	125.3	94.0
250	0.061	-	144.8	108.6	113.6	85.6	105.1	79.2
200	0.075	-	117.4	88.0	92.0	69.3	85.3	64.0
150	0.098	0.5	90.0	67.4	70.5	53.1	65.3	49.0
100	0.142	1	62.5	46.8	48.9	36.8	45.4	34.0

Field of View = CCD Size / Optical Magnification

### M2518-MPW2

- 2/3"
- 5MP
- FIX
- MANUAL

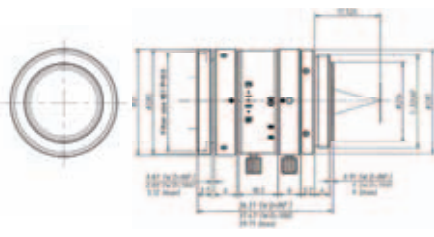

Focal Length	25mm				
Max. Aperture Ratio	1:1.8				
Max. Image Format	8.8mm x 6.6mm (φ 11mm)				
Operation Range	Iris	F1.8 - F16.0			
	Focus	0.2m - Inf.			
Control	Iris	Manual			
	Focus	Manual			
Angle of View	D	24.6°	19.5°	18.1°	
	H	2/3" 19.9°	1/1.8" 15.7°	1/2" 14.5°	
	V	15.0°	11.8°	10.9°	
Operating Temperature	-10°C ~ +50°C				

Optical Distortion	2/3"	0.03%(y=5.5)	1/1.8"	-0.02%(y=4.32)	1/2"	-0.02%(y=4.0)
BackFocalLength	13.8mm (WD=300mm)					
Flange Back Length	17.526mm					
Mount	C-Mount					
Filter Size	M27.0 P=0.5mm					
Dimensions	φ 29mm x 36.37mm					
Weight	60g					

Working Distance (mm)	Optical Magnification	Extension Ring (mm)	Field of View (mm)					
			2/3"		1/1.8"		1/2"	
			H	V	H	V	H	V
900	0.028	-	318.2	238.9	249.8	188.4	231.7	173.9
850	0.029	-	300.7	225.8	236.0	178.0	219.0	164.3
800	0.031	-	283.2	212.6	222.3	167.6	206.2	154.7
750	0.033	-	265.7	199.5	208.5	157.2	193.5	145.2
700	0.035	-	248.2	186.3	194.8	146.9	180.7	135.6
650	0.038	-	230.7	173.2	181.0	136.5	168.0	126.0
600	0.041	-	213.2	160.0	167.3	126.1	155.2	116.4
550	0.045	-	195.7	146.9	153.6	115.8	142.5	106.9
500	0.049	-	178.2	133.7	139.8	105.4	129.7	97.3
450	0.055	-	160.7	120.6	126.1	95.0	116.9	87.7
400	0.061	-	143.2	107.4	112.3	84.7	104.2	78.1
350	0.070	-	125.7	94.3	98.6	74.3	91.4	68.6
300	0.081	-	108.2	81.1	84.8	63.9	78.7	59.0
250	0.097	-	90.7	68.0	71.1	53.5	65.9	49.4
200	0.121	-	73.1	54.8	57.3	43.2	53.1	39.8
150	0.159	1	55.6	41.6	43.5	32.8	40.4	30.3
100	0.233	5	38.0	28.5	29.8	22.4	27.6	20.7

Field of View = CCD Size / Optical Magnification



# 2/3" 5 MEGAPIXEL FIXED FOCAL LENS (MPW2 Series)

2/3" 5MP  
MPW2

## M3520-MPW2

2/3"

5MP

FIX

MANUAL

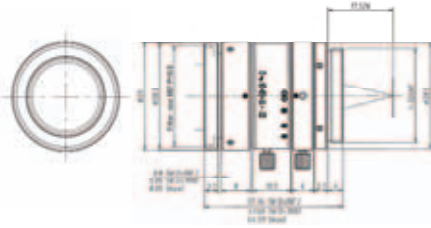

Focal Length	35mm				
Max. Aperture Ratio	1:2.0				
Max. Image Format	8.8mm x 6.6mm (φ 11mm)				
Operation Range	Iris	F2.0 - F22.0			
	Focus	0.2m - Inf.			
Control	Iris	Manual			
	Focus	Manual			
Angle of View	D	17.8°	14.0°	13.0°	
	H	2/3" 14.3°	1/1.8" 11.2°	1/2" 10.4°	
	V	10.7°	8.5°	7.8°	
Operating Temperature	-10°C ~ +50°C				

Optical Distortion	2/3"	0.011%(γ=5.5)	1/1.8"	0.010%(γ=4.32)	1/2"	0.009%(γ=4.0)
BackFocalLength	18.0mm (WD=300mm)					
FlangeBackLength	17.526mm					
Mount	C-Mount					
Filter Size	M27.0 P=0.5mm					
Dimensions	φ 29mm x 37.34mm					
Weight	59g					

Working Distance (mm)	Optical Magnification	Extension Ring (mm)	Field of View (mm)					
			2/3"		1/1.8"		1/2"	
			H	V	H	V	H	V
900	0.040	-	221.8	166.4	174.0	131.2	161.4	121.1
850	0.042	-	209.3	157.0	164.2	123.8	152.3	114.2
800	0.045	-	196.7	147.6	154.3	116.3	143.2	107.4
750	0.048	-	184.2	138.2	144.5	108.9	134.0	100.6
700	0.051	-	171.7	128.8	134.7	101.5	124.9	93.7
650	0.055	-	159.2	119.4	124.8	94.1	115.8	86.9
600	0.060	-	146.6	110.0	115.0	98.7	106.7	80.0
550	0.066	-	134.1	100.6	105.2	79.3	97.6	73.2
500	0.072	-	121.6	91.2	95.3	71.9	88.4	66.3
450	0.081	-	109.0	81.8	85.5	64.5	79.3	59.5
400	0.091	-	96.5	72.4	75.7	57.0	70.2	52.7
350	0.105	-	84.0	63.0	65.8	49.6	61.1	45.8
300	0.123	-	71.4	53.6	56.0	42.2	52.0	39.0
250	0.150	-	58.9	44.2	46.2	34.8	42.8	32.1
200	0.190	-	46.3	34.8	36.3	27.4	33.7	25.3
150	0.261	5	33.8	25.3	26.5	20.0	24.6	18.4
100	0.417	10	21.2	15.9	16.6	12.5	15.4	11.5

Field of View = CCD Size / Optical Magnification

## M5028-MPW2

2/3"

5MP

FIX

MANUAL

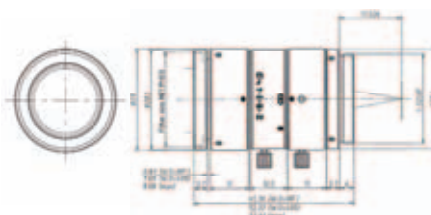

Focal Length	50mm				
Max. Aperture Ratio	1:2.8				
Max. Image Format	8.8mm x 6.6mm (φ 11mm)				
Operation Range	Iris	F2.8 - F32.0			
	Focus	0.4m - Inf.			
Control	Iris	Manual			
	Focus	Manual			
Angle of View	D	12.5°	9.9°	9.1°	
	H	2/3" 10.0°	1/1.8" 7.9°	1/2" 7.3°	
	V	7.5°	5.9°	5.5°	
Operating Temperature	-10°C ~ +50°C				

Optical Distortion	2/3"	0.027%(γ=5.5)	1/1.8"	0.017%(γ=4.32)	1/2"	0.015%(γ=4.0)
BackFocalLength	27.7mm (WD=400mm)					
FlangeBackLength	17.526mm					
Mount	C-Mount					
Filter Size	M27.0 P=0.5mm					
Dimensions	φ 29mm x 45.36mm					
Weight	69g					

Working Distance (mm)	Optical Magnification	Extension Ring (mm)	Field of View (mm)					
			2/3"		1/1.8"		1/2"	
			H	V	H	V	H	V
900	0.058	-	151.7	113.8	118.9	89.6	110.3	82.7
850	0.062	-	142.9	107.2	112.0	84.4	103.9	77.9
800	0.066	-	134.1	100.6	105.1	79.2	97.5	73.1
750	0.070	-	125.3	94.0	98.2	74.0	91.1	68.3
700	0.075	-	116.5	87.4	91.3	68.9	84.7	63.6
650	0.082	-	107.7	80.8	84.5	63.7	78.3	58.8
600	0.089	-	98.9	74.2	77.6	58.5	71.9	54.0
550	0.098	-	90.1	67.6	70.7	53.3	65.6	49.2
500	0.108	-	81.3	61.0	63.8	48.1	59.2	44.4
450	0.121	-	72.6	54.4	56.9	42.9	52.8	39.6
400	0.138	-	63.8	47.8	50.0	37.7	46.4	34.8
350	0.160	1	55.0	41.2	43.1	32.5	40.0	30.0
300	0.191	5	46.2	34.6	36.2	27.3	33.6	25.2
250	0.235	5	37.4	28.1	29.3	22.1	27.2	20.4
200	0.308	10	28.6	21.5	22.4	16.9	20.8	15.6
150	0.445	20	19.8	14.9	15.5	11.7	14.4	10.8
100	0.801	40	11.0	8.2	8.6	6.5	8.0	6.0

Field of View = CCD Size / Optical Magnification



- Same optical design as MPW2 series (2/3" 5MP)
- Redundant focus locks: lock nut plus locking screw
- Vibration resistance up to 10G

- All elements are bonded inside the lens housing
- Even more compact than MPW2 series

## M0824-MPW2-R series



Focal Length	8mm
Aperture (F)	F2.4/F4.0/F5.6/F8.0/F11.0
Max. Image Format	8.8mm x 6.6mm (φ 11)
Control	Iris Fix
	Focus Manual
Operation Range	0.05m - Inf.
Angle of View	D 69.32° 56.90° 53.23°
	H 2/3" 57.80° 1/1.8" 46.72° 1/2" 43.74°
	V 44.36° 35.75° 33.23°
Operating Temperature	-10°C ~ +50°C

Model	Aperture (F)
M0824-MPW2-R	2.4
M0840-MPW2-R	4.0
M0856-MPW2-R	5.6
M0880-MPW2-R	8.0
M0811-MPW2-R	11.0

## M1224-MPW2-R series



Focal Length	12mm
Aperture (F)	F2.4/F4.0/F5.6/F8.0/F11.0
Max. Image Format	8.8mm x 6.6mm (φ 11)
Control	Iris Fix
	Focus Manual
Operation Range	0.1m - Inf.
Angle of View	D 48.6° 39.1° 36.5°
	H 2/3" 39.8° 1/1.8" 31.7° 1/2" 29.5°
	V 30.4° 24.0° 22.3°
Operating Temperature	-10°C ~ +50°C

Model	Aperture (F)
M1224-MPW2-R	2.4
M1240-MPW2-R	4.0
M1256-MPW2-R	5.6
M1280-MPW2-R	8.0
M1211-MPW2-R	11.0

## M1620-MPW2-R series



Focal Length	16mm
Aperture (F)	F2.0/F4.0/F5.6/F8.0/F11.0
Max. Image Format	8.8mm x 6.6mm (φ 11)
Control	Iris Fix
	Focus Manual
Operation Range	0.2m - Inf.
Angle of View	D 37.7° 30.1° 28.0°
	H 2/3" 30.7° 1/1.8" 24.3° 1/2" 22.6°
	V 23.3° 18.5° 17.1°
Operating Temperature	-10°C ~ +50°C

Model	Aperture (F)
M1620-MPW2-R	2.0
M1640-MPW2-R	4.0
M1656-MPW2-R	5.6
M1680-MPW2-R	8.0
M1611-MPW2-R	11.0

## M2518-MPW2-R series



Focal Length	25mm
Aperture (F)	F1.8/F4.0/F5.6/F8.0/F11.0
Max. Image Format	8.8mm x 6.6mm (φ 11)
Control	Iris Fix
	Focus Manual
Operation Range	0.2m - Inf.
Angle of View	D 24.6° 19.5° 18.1°
	H 2/3" 19.9° 1/1.8" 15.7° 1/2" 14.5°
	V 15.0° 11.8° 10.9°
Operating Temperature	-10°C ~ +50°C

Model	Aperture (F)
M2518-MPW2-R	1.8
M2540-MPW2-R	4.0
M2556-MPW2-R	5.6
M2580-MPW2-R	8.0
M2511-MPW2-R	11.0

## M3520-MPW2-R series



Focal Length	35mm
Aperture (F)	F2.0/F4.0/F5.6/F8.0/F11.0
Max. Image Format	8.8mm x 6.6mm (φ 11)
Control	Iris Fix
	Focus Manual
Operation Range	0.2m - Inf.
Angle of View	D 17.8° 14.0° 13.0°
	H 2/3" 14.3° 1/1.8" 11.2° 1/2" 10.4°
	V 10.7° 8.5° 7.8°
Operating Temperature	-10°C ~ +50°C

Model	Aperture (F)
M3520-MPW2-R	2.0
M3540-MPW2-R	4.0
M3556-MPW2-R	5.6
M3580-MPW2-R	8.0
M3511-MPW2-R	11.0

## M5028-MPW2-R series



Focal Length	50mm
Aperture (F)	F2.8/F4.0/F5.6/F8.0/F11.0
Max. Image Format	8.8mm x 6.6mm (φ 11)
Control	Iris Fix
	Focus Manual
Operation Range	0.4m - Inf.
Angle of View	D 12.5° 9.9° 9.1°
	H 2/3" 10.0° 1/1.8" 7.9° 1/2" 7.3°
	V 7.5° 5.9° 5.5°
Operating Temperature	-10°C ~ +50°C

Model	Aperture (F)
M5028-MPW2-R	2.8
M5040-MPW2-R	4.0
M5056-MPW2-R	5.6
M5080-MPW2-R	8.0
M5011-MPW2-R	11.0



# 2/3" 1.5 MEGA PIXEL FIXED FOCAL LENS (MP2 Series)

2/3" 1.5MP  
MP2

- 5, 8, 12, 16, 25, 35, 50, 75mm 8 lens series
- Compatible with 2/3" format sensor (H0514-MP2 : 1/2")
- Low distortion (Less than 1.0%)

- Locking set screws for focus and iris
- Compact design - diameter 33.5mm (H0514-MP2 : 44.5mm)

## H0514-MP2

- 1/2"
- 1.5MP
- FIX
- MANUAL
- WIDE

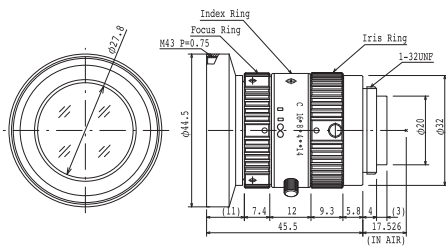

Focal Length	5mm		
Max. Aperture Ratio	1:1.4		
Max. Image Format	6.4mm x 4.8mm ( $\phi 8$ mm)		
Operation Range	Iris	F1.4 - F16C	
	Focus	0.1m - 0.9m	
Control	Iris	Manual	
	Focus	Manual	
Angle of View	D	76.7°	62.3°
	H	1/2" 65.5°	1/3" 51.4°
	V	51.4°	39.5°
Operating Temperature	-10° C ~ +50° C		

Optical Distortion	1/2"	-0.48% (y=4.0)	1/3"	-2.26% (y=3.0)
BackFocal Length	10.8mm (WD=900mm)			
Flange Back Length	17.526mm			
Mount	C-Mount			
Filter Size	M43 P=0.75mm			
Dimensions	$\phi 44.5$ mm x 45.5mm			
Weight	102g			

Working Distance (mm)	Optical Magnification	Extension Ring (mm)	Field of View (mm)			
			1/2"		1/3"	
			H	V	H	V
900	0.006	-	1179.8	882.3	882.3	657.2
850	0.006	-	1115.4	834.2	834.2	621.3
800	0.006	-	1051.0	786.0	786.0	585.4
750	0.007	-	986.6	737.8	737.8	549.5
700	0.007	-	922.3	689.6	689.6	513.6
650	0.008	-	857.9	641.4	641.4	477.7
600	0.008	-	793.5	593.2	593.2	441.8
550	0.009	-	729.1	545.0	545.0	405.9
500	0.010	-	664.7	496.9	496.9	370.0
450	0.011	-	600.3	448.7	448.7	334.1
400	0.012	-	535.9	400.5	400.5	298.2
350	0.014	-	471.5	352.3	352.3	262.3
300	0.016	-	407.1	304.1	304.1	226.4
250	0.019	-	342.7	255.9	255.9	190.5
200	0.024	-	278.4	207.8	207.8	154.6
150	0.031	-	214.0	159.6	159.6	118.7
100	0.044	-	149.6	111.4	111.4	82.8

Field of View = CCD Size / Optical Magnification

## M0814-MP2

- 2/3"
- 1.5MP
- FIX
- MANUAL

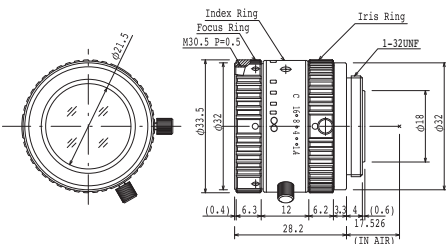

Focal Length	8mm		
Max. Aperture Ratio	1:1.4		
Max. Image Format	8.8mm x 6.6mm ( $\phi 11$ mm)		
Operation Range	Iris	F1.4 - F16C	
	Focus	0.1m - Inf.	
Control	Iris	Manual	
	Focus	Manual	
Angle of View	D	67.1°	51.9°
	H	2/3" 56.3°	1/2" 42.5°
	V	43.7°	32.4°
Operating Temperature	-10° C ~ +50° C		

Optical Distortion	2/3"	-0.1% (y=5.5)	1/2"	-1.1% (y=4.0)
BackFocal Length	13.1mm (Inf)			
Flange Back Length	17.526mm			
Mount	C-Mount			
Filter Size	M30.5 P=0.5mm			
Dimensions	$\phi 33.5$ mm x 28.2mm			
Weight	63g			

Working Distance (mm)	Optical Magnification	Extension Ring (mm)	Field of View (mm)			
			2/3"		1/2"	
			H	V	H	V
900	0.009	-	976.8	731.5	709.1	530.1
850	0.010	-	923.3	691.4	670.2	501.0
800	0.010	-	869.8	651.3	631.4	471.9
750	0.011	-	816.3	611.2	592.5	442.8
700	0.012	-	762.8	571.1	553.6	413.8
650	0.013	-	709.3	531.0	514.7	384.7
600	0.014	-	655.8	490.9	475.8	355.6
550	0.015	-	602.3	450.8	437.0	326.5
500	0.016	-	548.8	410.7	398.1	297.5
450	0.018	-	495.3	370.6	359.2	268.4
400	0.020	-	441.8	330.5	320.3	239.3
350	0.023	-	388.3	290.4	281.4	210.2
300	0.027	-	334.8	250.3	242.6	181.2
250	0.032	-	281.2	210.2	203.7	152.1
200	0.039	-	227.7	170.0	164.8	123.0
150	0.052	-	174.2	129.9	125.9	93.9
100	0.075	-	120.7	89.8	87.0	64.9

Field of View = CCD Size / Optical Magnification

2/3" 1.5MP  
MP2

## 2/3" 1.5 MEGAPIXEL FIXED FOCAL LENS (MP2 Series)



- 5, 8, 12, 16, 25, 35, 50, 75mm 8 lens series
- Compatible with 2/3" format sensor (H0514-MP2 : 1/2")
- Low distortion (Less than 1.0%)

- Locking set screws for focus and iris
- Compact design - diameter 33.5mm (H0514-MP2 : 44.5mm)

### M1214-MP2

- 2/3"
- 1.5MP
- FIX
- MANUAL

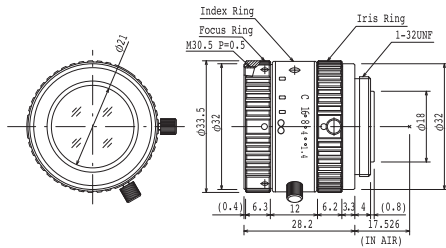

Focal Length	12mm		
Max. Aperture Ratio	1:1.4		
Max. Image Format	8.8mm x 6.6mm (φ11mm)		
Operation Range	Iris	F1.4 - F16C	
	Focus	0.15m - Inf.	
Control	Iris	Manual	
	Focus	Manual	
Angle of View	D		49.2°
			37.0°
	H	2/3"	40.4°
V		30.8°	
			22.7°
Operating Temperature	-10°C ~ +50°C		

Optical Distortion	2/3"	-0.1% (y=5.5)	1/2"	-0.35% (y=4.0)
BackFocal Length	13.1mm (Inf)			
Flange Back Length	17.526mm			
Mount	C-Mount			
Filter Size	M30.5 P=0.5mm			
Dimensions	φ 33.5mm x 28.2mm			
Weight	62g			

Working Distance (mm)	Optical Magnification	Extension Ring (mm)	Field of View (mm)			
			2/3"		1/2"	
			H	V	H	V
900	0.013	-	672.7	504.0	488.7	366.0
850	0.014	-	635.9	476.4	461.9	345.9
800	0.015	-	599.1	448.9	435.2	325.9
750	0.016	-	562.4	421.3	408.4	305.9
700	0.017	-	525.6	393.7	381.7	285.8
650	0.018	-	488.8	366.1	355.0	265.8
600	0.020	-	452.1	338.5	328.2	245.7
550	0.021	-	415.3	311.0	301.5	225.7
500	0.023	-	378.5	283.4	274.7	205.7
450	0.026	-	341.7	255.8	248.0	185.6
400	0.029	-	305.0	228.2	221.2	165.6
350	0.033	-	268.2	200.6	194.5	145.6
300	0.038	-	231.4	173.0	167.7	125.5
250	0.046	-	194.7	145.5	141.0	105.5
200	0.056	-	157.9	117.9	114.3	85.4
150	0.074	-	121.1	90.3	87.5	65.4
100	0.106	0.5	84.3	62.7	60.8	45.4

Field of View = CCD Size / Optical Magnification

### M1614-MP2

- 2/3"
- 1.5MP
- FIX
- MANUAL

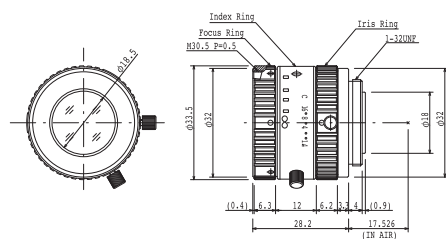

Focal Length	16mm		
Max. Aperture Ratio	1:1.4		
Max. Image Format	8.8mm x 6.6mm (φ11mm)		
Operation Range	Iris	F1.4 - F16C	
	Focus	0.3m - Inf.	
Control	Iris	Manual	
	Focus	Manual	
Angle of View	D		38.0°
			28.2°
	H	2/3"	30.8°
V		23.4°	
			17.1°
Operating Temperature	-10°C ~ +50°C		

Optical Distortion	2/3"	-0.1% (y=5.5)	1/2"	-0.3% (y=4.0)
BackFocal Length	13.1mm (Inf)			
Flange Back Length	17.526mm			
Mount	C-Mount			
Filter Size	M30.5 P=0.5mm			
Dimensions	φ 33.5mm x 28.2mm			
Weight	60g			

Working Distance (mm)	Optical Magnification	Extension Ring (mm)	Field of View (mm)			
			2/3"		1/2"	
			H	V	H	V
900	0.018	-	503.2	376.8	365.4	273.7
850	0.019	-	475.6	356.2	345.3	258.6
800	0.020	-	448.0	335.5	325.3	243.6
750	0.021	-	420.4	314.8	305.2	228.6
700	0.023	-	392.8	294.1	285.2	213.6
650	0.024	-	365.2	273.4	265.1	198.5
600	0.026	-	337.6	252.8	245.1	183.5
550	0.029	-	310.0	232.1	225.0	168.5
500	0.031	-	282.5	211.4	204.9	153.5
450	0.035	-	254.9	190.7	184.9	138.4
400	0.039	-	227.3	170.0	164.8	123.4
350	0.044	-	199.7	149.4	144.8	108.4
300	0.052	-	172.1	128.7	124.7	93.4
250	0.061	-	144.5	108.0	104.7	78.3
200	0.076	-	116.9	87.3	84.6	63.3
150	0.100	0.5	89.3	66.6	64.6	48.3
100	0.145	1.0	61.7	45.9	44.5	33.2

Field of View = CCD Size / Optical Magnification



# 2/3" 1.5 MEGA PIXEL FIXED FOCAL LENS (MP2 Series)

2/3" 1.5MP  
MP2

## M2514-MP2

- 2/3"
- 1.5MP
- FIX
- MANUAL

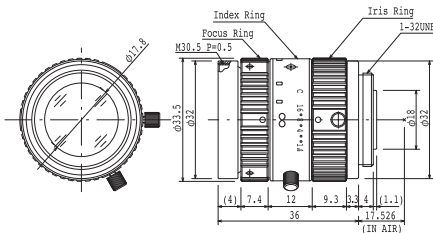

Focal Length	25mm		
Max. Aperture Ratio	1:1.4		
Max. Image Format	8.8mm x 6.6mm (φ11mm)		
Operation Range	Iris	F1.4 - F16C	
	Focus	0.3m - Inf.	
Control	Iris	Manual	
	Focus	Manual	
Angle of View	D	24.9°	18.2°
	H	2/3" 20.0°	1/2" 14.6°
	V	15.1°	11.0°
Operating Temperature	-10° C ~ +50° C		

Optical Distortion	2/3"	-0.3% (y=5.5)	1/2"	-0.1% (y=4.0)
BackFocal Length	13.1mm (Inf)			
Flange Back Length	17.526mm			
Mount	C-Mount			
Filter Size	M30.5 P=0.5mm			
Dimensions	φ 33.5mm x 36.0mm			
Weight	71g			

Working Distance (mm)	Optical Magnification	Extension Ring (mm)	Field of View (mm)			
			2/3"		1/2"	
			H	V	H	V
900	0.028	-	317.5	237.7	230.5	172.7
850	0.029	-	299.9	224.5	217.7	163.1
800	0.031	-	282.3	211.3	204.8	153.5
750	0.033	-	264.6	198.1	192.0	143.9
700	0.036	-	247.0	184.9	179.2	134.3
650	0.039	-	229.4	171.6	166.4	124.7
600	0.042	-	211.8	158.4	153.6	115.1
550	0.046	-	194.1	145.2	140.8	105.5
500	0.050	-	176.5	132.0	128.0	95.9
450	0.056	-	158.9	118.8	115.2	86.3
400	0.063	-	141.2	105.6	102.4	76.7
350	0.072	-	123.6	92.4	89.6	67.1
300	0.084	-	106.0	79.2	76.8	57.5
250	0.100	-	88.3	66.0	63.9	47.9
200	0.126	-	70.7	52.7	51.1	38.3
150	0.168	-	53.0	39.5	38.3	28.7
100	0.253	1.5	35.3	26.3	25.5	19.0

Field of View = CCD Size / Optical Magnification

## M3514-MP

- 2/3"
- 1.5MP
- FIX
- MANUAL

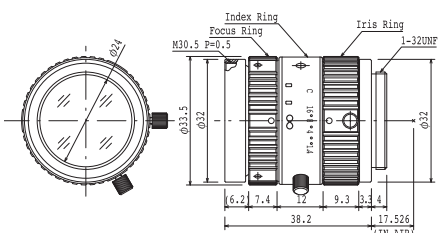

Focal Length	35mm		
Max. Aperture Ratio	1:1.4		
Max. Image Format	8.8mm x 6.6mm (φ11mm)		
Operation Range	Iris	F1.4 - F16C	
	Focus	0.3m - Inf.	
Control	Iris	Manual	
	Focus	Manual	
Angle of View	D	17.3°	12.6°
	H	2/3" 13.9°	1/2" 10.1°
	V	10.4°	7.6°
Operating Temperature	-10° C ~ +50° C		

Optical Distortion	2/3"	-0.8% (y=5.5)	1/2"	-0.4% (y=4.0)
BackFocal Length	17.1mm (WD=400mm)			
Flange Back Length	17.526mm			
Mount	C-Mount			
Filter Size	M30.5 P=0.5mm			
Dimensions	φ 33.5mm x 38.2mm			
Weight	87g			

Working Distance (mm)	Optical Magnification	Extension Ring (mm)	Field of View (mm)			
			2/3"		1/2"	
			H	V	H	V
900	0.037	-	236.2	176.9	171.5	128.6
850	0.040	-	223.2	167.2	162.1	121.5
800	0.042	-	210.3	157.5	152.7	114.5
750	0.045	-	197.3	147.8	143.3	107.4
700	0.048	-	184.3	138.1	133.9	100.3
650	0.052	-	171.4	128.4	124.5	93.3
600	0.056	-	158.4	118.6	115.0	86.2
550	0.061	-	145.5	108.9	105.6	79.1
500	0.067	-	132.5	99.2	96.2	72.1
450	0.074	-	119.6	89.5	86.8	65.0
400	0.083	-	106.6	79.8	77.4	58.0
350	0.094	-	93.7	70.1	67.9	50.9
300	0.110	-	80.7	60.4	58.5	43.8
250	0.131	1	67.7	50.6	49.1	36.8
200	0.162	2	54.7	40.9	39.7	29.7
150	0.213	5	41.8	31.2	30.2	22.6
100	0.310	7	28.7	21.4	20.8	15.5

Field of View = CCD Size / Optical Magnification

2/3" 1.5MP  
MP2

## 2/3" 1.5 MEGAPIXEL FIXED FOCAL LENS (MP2 Series)



- 5, 8, 12, 16, 25, 35, 50, 75mm 8 lens series
- Compatible with 2/3" format sensor (H0514-MP2 : 1/2")
- Low distortion (Less than 1.0%)

- Locking set screws for focus and iris
- Compact design - diameter 33.5mm (H0514-MP2 : 44.5mm)

### M5018-MP2

- 2/3"
- 1.5MP
- FIX
- MANUAL

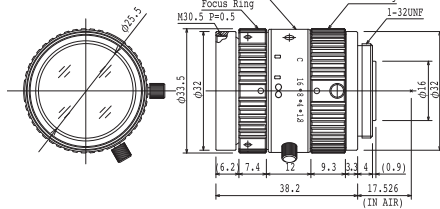

Focal Length	50mm				
Max. Aperture Ratio	1:1.8				
Max. Image Format	8.8mm x 6.6mm (φ11mm)				
Operation Range	Iris	F1.8 - F16C			
	Focus	0.5m - Inf.			
Control	Iris	Manual			
	Focus	Manual			
Angle of View	D		13.1°		9.5°
		H	2/3"	10.5°	1/2"
	V		7.9°		5.7°
Operating Temperature	-10°C ~ +50°C				

Optical Distortion	2/3"	-0.3% (y=5.5)	1/2"	-0.2% (y=4.0)
Back Focal Length	13.1mm (Inf)			
Flange Back Length	17.526mm			
Mount	C-Mount			
Filter Size	M30.5 P=0.5mm			
Dimensions	φ 33.5mm x 38.2mm			
Weight	85g			

Working Distance (mm)	Optical Magnification	Extension Ring (mm)	Field of View (mm)			
			2/3"		1/2"	
			H	V	H	V
900	0.055	-	160.8	120.4	116.7	87.5
850	0.058	-	151.6	113.5	110.1	82.5
800	0.062	-	142.4	106.6	103.4	77.5
750	0.066	-	133.2	99.7	96.7	72.5
700	0.071	-	124.0	92.9	90.0	67.5
650	0.077	-	114.8	86.0	83.4	62.5
600	0.084	-	105.6	79.1	76.7	57.5
550	0.092	-	96.5	72.2	70.1	52.5
500	0.101	-	87.3	65.3	63.3	47.5
450	0.113	0.5	78.1	58.4	56.7	42.5
400	0.128	1.5	68.9	51.6	50.0	37.5
350	0.148	2.5	59.7	44.7	43.3	32.5
300	0.175	3.5	50.5	37.8	36.6	27.4
250	0.214	5.5	41.3	30.9	30.0	22.4
200	0.276	8.5	32.1	24.0	23.3	17.4
150	0.387	14.0	22.9	17.1	16.6	12.4
100	0.647	26.5	13.6	10.2	9.9	7.4

Field of View = CCD Size / Optical Magnification

### M7528-MP

- 2/3"
- 1.5MP
- FIX
- MANUAL
- TELE

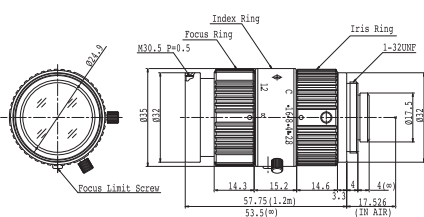

Focal Length	75mm				
Max. Aperture Ratio	1:2.8				
Max. Image Format	8.8mm x 6.6mm (φ11mm)				
Operation Range	Iris	F2.8 - F16C			
	Focus	0.3m - Inf. (※)			
Control	Iris	Manual			
	Focus	Manual			
Angle of View	D		8.5°		6.2°
		H	2/3"	6.8°	1/2"
	V		5.1°		3.7°
Operating Temperature	-10°C ~ +50°C				

Optical Distortion	2/3"	-0.4% (y=5.5)	1/2"	-0.2% (y=4.0)
Back Focal Length	21.5mm (WD=400mm)			
Flange Back Length	17.526mm			
Mount	C-Mount			
Filter Size	M30.5 P=0.5mm			
Dimensions	φ 35mm x 57.75mm			
Weight	113g			

※ Factory setting is 0.3-1.2m. Focus can be adjusted to infinity by removing "Focus Limit Screw".

Working Distance (mm)	Optical Magnification	Extension Ring (mm)	Field of View (mm)			
			2/3"		1/2"	
			H	V	H	V
900	0.077	-	113.8	85.4	82.8	62.1
850	0.082	-	107.8	80.8	78.4	58.8
800	0.086	-	101.7	76.3	74.0	55.5
750	0.092	-	95.7	71.8	69.6	52.2
700	0.098	-	89.6	67.2	65.2	48.9
650	0.105	-	83.6	62.7	60.8	45.6
600	0.114	-	77.6	58.1	56.4	42.3
550	0.123	-	71.5	53.6	52.0	39.0
500	0.135	-	65.5	49.1	47.6	35.7
450	0.148	-	59.4	44.5	43.2	32.4
400	0.165	-	53.4	40.0	38.8	29.1
350	0.187	-	47.3	35.4	34.4	25.8
300	0.214	-	41.3	30.9	30.0	22.5
250	0.251	5	35.2	26.4	25.6	19.1
200	0.304	7	29.2	21.8	21.2	15.8
150	0.384	13	23.1	17.3	16.8	12.5
100	0.522	23	17.1	12.7	12.3	9.2

Field of View = CCD Size / Optical Magnification





# 2/3" 1 MEGAPIXEL VARI-FOCAL LENS

2/3" 1MP  
VARI

• Useful range of focal length for machine vision: f=12mm - 36mm • Locking set screws for zoom, focus and iris

## M3Z1228C-MP

- 2/3"
- 1MP
- VARI
- MANUAL

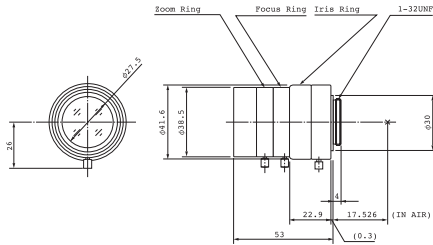

Focal Length	12mm - 36mm		
Max. Aperture Ratio	1:2.8		
Max. Image Format	8.8mm x 6.6mm ( φ 11mm)		
Operation Range	Iris	F2.8 - F16C	
	Focus	0.2m - Inf.(Tele) 0.05m - Inf.(Wide)	
	Zoom	12mm - 36mm	
Control	Iris	Manual	
	Focus	Manual	
	Zoom	Manual	
Object Dimension at M.O.D.	12mm	40.0(H)mm x 30.0(V)mm 2/3"	
	36mm	48.0(H)mm x 36.0(V)mm 2/3"	
Angle of View	D	50.4° - 16.8°	37.5° - 12.5°
	H	2/3" 41.0° - 13.6°	1/2" 30.2° - 10.0°
	V	31.2° - 10.4°	22.8° - 7.6°
Operating Temperature	-10°C ~ +50°C		

※ Please note M3Z1228C-MP is produced to order

Effective Lens Aperture	Front	φ 27.2mm		
	Rear	φ 12.1mm		
Back Focal Length	Tele	13.5mm		
	Wide	14.7mm		
Optical Distortion	Tele	2/3"	1/2"	+3.5%(y=5.5)
				+1.7%(y=4.0)
	Wide	2/3"	1/2"	-2.6% (y=5.5)
				-1.9%(y=4.0)
Flange Back Length	17.526mm			
Mount	C-Mount			
Filter Size	M35.5 P=0.5mm			
Dimensions	φ 41.6mm x 53mm			
Weight	105g			





# MEGAPIXEL MACRO ZOOM LENS

2/3" 1MP  
MACRO  
ZOOM

- Captures full resolution of megapixel cameras
- High contrast & sharp picture in all areas of the screen
- Compact design - 36.5mm diameter
- Locking set screws for zoom, focus, and iris
- Low distortion
- High resolution macro zoom lens
- 3.3X magnification
- Fiber-optic ring illumination compatible (Ring guide: M34 P=0.5)

2/3"

## MLM-3XMP

1MP

MACRO

ZOOM

MANUAL



Max. Magnification	0.3X - 1.0X			Optical Distortion	2/3"	+0.12% at 0.3X (y=5.5)	1/2"	+0.12% at 0.3X (y=4.0)	
Max. Aperture Ratio	1:4.5					+1.78% at 1.0X (y=5.5)		+0.77% at 1.0X (y=4.0)	
Max. Image Format	8.8mm x 6.6mm (φ 11mm)			Back Focal Length	20.4mm				
Operation Range	Iris	F4.5 - F22C			Flange Back Length	17.526mm			
	Focus	90mm			Mount	C-Mount			
Control	Iris	Manual			Filter Size	M34 P=0.5mm			
	Focus	Manual			Dimensions	φ 36.5mm x 79.5mm			
	Zoom	Manual			Weight	150g			
Angle of View	D	14.88° - 2.84°		2/3"	1/2"	10.70° - 2.72°			
	H	11.80° - 2.78°				8.48° - 2.18°			
	V	8.74° - 2.24°				6.38° - 1.64°			
Operating Temperature	-10° C ~ +50° C								

Monitor Magnification on 14inch Monitor  
Working Distance: 90mm  
Magnification on Monitor = Optical Magnification x Monitor Size / CCD Size

Optical Magnification	Field of View (mm)											
	2/3"			Magnification on Monitor	1/2"			Magnification on Monitor	1/3"			Magnification on Monitor
	H	V	D		H	V	D		H	V	D	
0.3X	29.3	22.0	36.7	9.7X	21.3	16.0	26.7	13.3X	16.0	12.0	20.0	17.8X
0.4X	22.0	16.5	27.5	12.9X	16.0	12.0	20.0	17.8X	12.0	9.0	15.0	23.7X
0.5X	17.6	13.2	22.0	16.2X	12.8	9.6	16.0	22.2X	9.6	7.2	12.0	29.6X
0.6X	14.7	11.0	18.3	19.4X	10.7	8.0	13.3	26.7X	8.0	6.0	10.0	35.6X
0.7X	12.6	9.4	15.7	22.6X	9.1	6.9	11.4	31.1X	6.9	5.1	8.6	41.5X
0.8X	11.0	8.3	13.8	25.9X	8.0	6.0	10.0	35.6X	6.0	4.5	7.5	47.4X
0.9X	9.8	7.3	12.2	29.1X	7.1	5.3	8.9	40.0X	5.3	4.0	6.7	53.3X
1.0X	8.8	6.6	11.0	32.3X	6.4	4.8	8.0	44.5X	4.8	3.6	6.0	59.3X

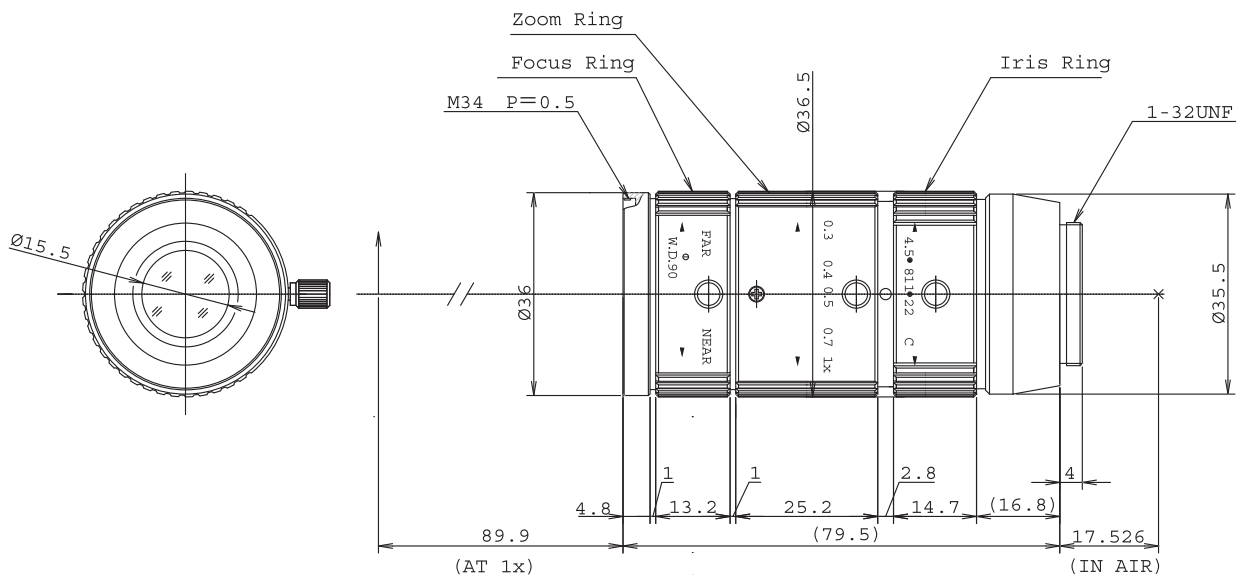

1.1" 5MP  
TELECENTRIC  
MACRO ZOOM

# 5 MEGAPIXEL TELECENTRIC MACRO ZOOM LENS



- 5 megapixel resolution for 1.1" sensor
- 7.1X magnification (0.5X - 0.07X)
- Relative illumination rate is more than 70%

- Adjustable W.D. (182mm - 577.2mm)
- Telecentric design at 0.25X - 0.5X

## TEC-V7X

- 1.1"
- 5MP
- TELECENTRIC
- MACRO
- ZOOM
- MANUAL



Optical Magnification	0.07X - 0.5X
Max. Aperture Ratio	1 : 4.3
Max. Image Format	12.3mm x 12.3mm (φ 17.4mm)
Operation Range	Iris F4.3 - F32
	Focus 182mm - 577.2mm
Control	Iris Manual operation
	Focus Manual operation
	Zoom Manual operation
Operating Temperature	-10° C ~ 50° C

Optical Distortion	Tele	1.0%	1"	0.84%	2/3"	0.39%
	Wide	-1.7%		-1.45%		-0.7%
Back Focal Length	Tele	39.53mm				
	Wide	49.78mm				
Flange Back Length	17.526mm					
Mount	C Mount					
Filter Size	M62 P=0.75mm					
Dimensions	φ 61 x 152.86mm					
Weight	1.4kg					

Working Distance(mm)	Optical Magnification	Field of View (mm)									
		1.1"			1"			2/3"			
(mm)		H	V	D	H	V	D	H	V	D	
182	Wide	0.2525	48.74	48.74	69.12	50.32	38.06	63.28	34.88	26.16	43.6
	Middle	0.3643	33.64	33.64	47.33	34.72	26.3	43.6	24.12	18.1	30.11
	Tele	0.5	24.6	24.6	34.75	25.4	19.246	31.88	17.65	13.26	22
200	Wide	0.2258	54.52	54.62	76.94	56.3	42.56	70.84	39	29.24	48.76
	Middle	0.3258	37.62	37.62	52.95	38.83	29.4	48.78	26.96	20.24	33.67
	Tele	0.4451	27.5	27.5	38.68	28.38	21.51	35.64	19.72	14.81	24.62
300	Wide	0.1413	87.48	87.48	124.06	90.34	68.18	114.1	62.46	46.8	78.178
	Middle	0.2037	60.24	60.24	85.34	62.18	47.06	78.18	42.15	32.38	53.898
	Tele	0.2784	44	44	61.94	45.42	34.3	57.46	31.55	23.69	39.38
400	Wide	0.1037	119.47	119.47	169.98	123.4	93.02	156.05	85.2	63.82	106.71
	Middle	0.1495	82.15	82.15	115.97	84.8	64.16	106.72	58.82	44.12	73.48
	Tele	0.2042	59.99	59.99	84.52	61.92	46.89	77.82	43	32.28	53.7
500	Wide	0.082	151.25	151.25	215.44	156.25	117.67	197.8	107.78	80.68	135.04
	Middle	0.1183	103.92	103.92	146.82	107.28	81.12	135	74.37	55.78	92.94
	Tele	0.1617	75.84	75.84	106.89	78.29	59.28	98.4	54.36	40.8	67.88
577.5	Wide	0.0708	175.21	175.21	250.66	181.4	136.35	229.82	125.08	93.62	156.76
	Middle	0.102	120.57	120.57	170.44	124.47	94.1	156.74	86.28	64.72	107.84
	Tele	0.1398	87.99	87.99	124.04	90.8	68.75	114.16	63.06	47.32	78.74

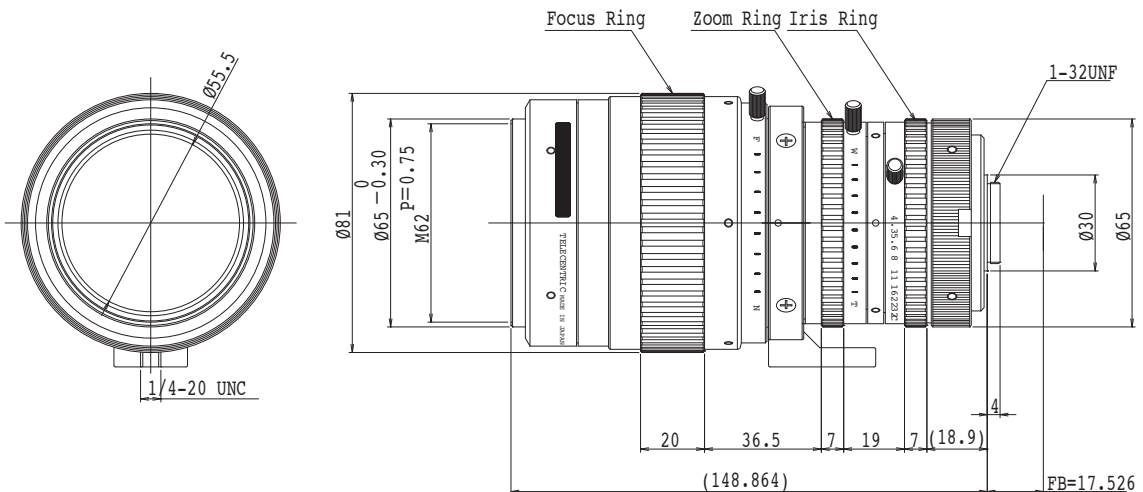



# 5 MEGAPIXEL TELECENTRIC MACRO LENS

2/3" 5MP  
TELECENTRIC  
MACRO

- Compact body design, compatible with 5MP sensors
- Optical magnification 0.057x - 0.5x

- Relative illuminance more than 80%
- Low distortion, less than 1%

## TEC-M55MPW

- 2/3"
- 5MP
- TELECENTRIC
- MACRO
- MANUAL



Focal length	55mm (at 0.057X) 51mm (at 0.5X)	Optical Distortion	2/3"	+0.52% at 0.057x (y=5.5) +0.6% at 0.5x (y=5.5)
Max. Aperture Ratio	1:3.0	Back focal length	17.0mm	
Max. Image Format	8.8mm x 6.6mm (φ11mm)	Flange Back Length	17.526mm	
Operation Range	Iris F3.0-F22C Focus 139mm - 1000mm	Mount	C-Mount	
Magnification	0.057x - 0.5x	Filter Size	M46.0 P=0.75mm	
Relative Illumination	94% (at 0.057x) 81% (at 0.5x)	Dimensions	φ59.0mm x 93.1mm	
Control	Iris Manual Focus Manual	Weight	470g	
Operation Temperature	-10° C ~ 50° C			

Working Distance(mm)	Optical Magnification (X)	Field of View (mm)					
		2/3"		1/2"		1/3"	
(mm)	(X)	H	V	H	V	H	V
1000	0.057	154.4	115.8	112.3	84.2	84.2	63.2
950	0.060	146.7	110.0	106.7	80.0	80.0	60.0
900	0.064	137.5	103.1	100.0	75.0	75.0	56.3
850	0.067	131.3	98.5	95.5	71.6	71.6	53.7
800	0.072	122.2	91.7	88.9	66.7	66.7	50.0
750	0.077	114.3	85.7	83.1	62.3	62.3	46.8
700	0.083	106.0	79.5	77.1	57.8	57.8	43.4
650	0.089	98.9	74.2	71.9	53.9	53.9	40.4
600	0.097	90.7	68.0	66.0	49.5	49.5	37.1
550	0.106	83.0	62.3	60.4	45.3	45.3	34.0
500	0.118	74.6	55.9	54.2	40.7	40.7	30.5
450	0.132	66.7	50.0	48.5	36.4	36.4	27.3
400	0.150	58.7	44.0	42.7	32.0	32.0	24.0
350	0.173	50.9	38.2	37.0	27.7	27.7	20.8
300	0.204	43.1	32.4	31.4	23.5	23.5	17.6
250	0.251	35.1	26.3	25.5	19.1	19.1	14.3
200	0.323	27.2	20.4	19.8	14.9	14.9	11.1
150	0.456	19.3	14.5	14.0	10.5	10.5	7.9
140	0.504	17.5	13.1	12.7	9.5	9.5	7.1

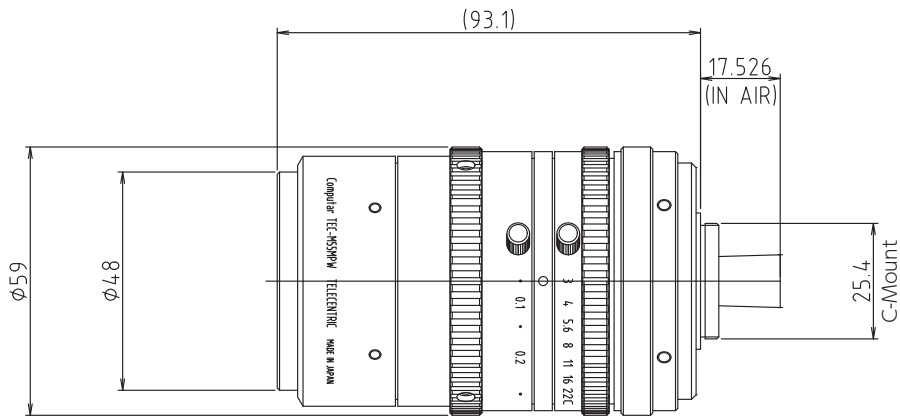



- Very low distortion compared to standard macro lenses
- Wide depth of field
- Working distance: 140mm - infinity

- Suitable for use as a telephoto lens and macro lens
- Fast F-Stop design at infinity (F2.8)

## TEC-M55

- 2/3"
- TELECENTRIC
- MACRO
- MANUAL



Focal Length	55mm
Max. Aperture Ratio	1:2.8
Max. Image Format	8.8mm x 6.6mm (φ 11mm)
Operation Range	Iris F2.8 - F32C
	Focus 140mm - Inf.
Magnification	Inf. - 0.5X (Max 1.0X at 140mm with 2X Converter)
Relative Illumination	78.5% (at 0.5X)
Depth of Field	1/2" 3.5mm(at 0.5X F2.8), 6.0mm(at 0.5X F5.6)
Control	Iris Manual
	Focus Manual
Operating Temperature	-20° C ~ +50° C

Optical Distortion	2/3"	+0.2% at 0.2X (y=5.5)	+0.1% at 0.2X (y=4.0)
		+0.6% at 0.5X (y=5.5)	+0.3% at 0.5X (y=4.0)
Back Focal Length	29.8mm		
Flange Back Length	17.526mm		
Mount	C-Mount		
Filter Size	M43 P=0.75mm		
Dimensions	φ 53.0mm x 92.9mm (Max. at 0.5X)		
Weight	320g		

### TEC-M55

Working Distance (mm)	Optical Magnification	Field of View (mm)					
		2/3"		1/2"		1/3"	
		H	V	H	V	H	V
5000	0.011X	796.2	597.8	579.7	435.0	435.0	326.3
4000	0.014X	636.1	477.6	463.1	347.5	347.5	260.7
3000	0.018X	476.0	357.4	346.6	260.1	260.1	195.1
2000	0.028X	315.9	237.2	230.0	172.6	172.6	129.5
1500	0.037X	235.9	177.1	177.1	128.9	128.9	96.7
1000	0.056X	155.8	117.0	113.4	85.1	85.1	63.9
950	0.059X	147.8	111.0	107.6	80.7	80.7	60.6
900	0.063X	139.8	105.0	101.8	76.4	76.4	57.3
850	0.067X	131.8	99.0	96.0	72.0	72.0	54.0
800	0.071X	123.8	92.9	90.1	67.6	67.6	50.7
750	0.076X	115.8	86.9	84.3	63.2	63.2	47.4
700	0.081X	107.8	80.9	78.5	58.9	58.9	44.2
650	0.088X	99.8	74.9	72.6	55.5	55.5	40.9
600	0.096X	91.8	68.9	66.8	50.1	50.1	37.6
550	0.105X	83.8	62.9	61.0	45.8	45.8	34.3
500	0.116X	75.8	56.9	55.2	41.4	41.4	31.0
450	0.130X	67.8	50.9	49.3	37.0	37.0	27.8
400	0.147X	59.8	44.9	43.5	32.6	32.6	24.5
350	0.170X	51.8	38.8	37.7	28.3	28.3	21.2
300	0.201X	43.8	32.8	31.8	23.9	23.9	17.9
250	0.246X	35.7	26.8	26.0	19.5	19.5	14.6
200	0.317X	27.7	20.8	20.2	15.1	15.1	11.4
150	0.446X	19.7	14.8	14.3	10.8	10.8	8.1
140	0.486X	18.1	13.6	13.2	9.9	9.9	7.4

### TEC-M55 with 0.75X Converter

Working Distance (mm)	Optical Magnification	Field of View (mm)					
		2/3"		1/2"		1/3"	
		H	V	H	V	H	V
5000	0.008X	1066.2	797.6	773.3	579.2	579.2	434.0
4000	0.010X	851.9	637.3	617.8	462.7	462.7	346.8
3000	0.014X	637.6	476.9	462.4	346.3	346.3	259.5
2000	0.021X	423.2	316.6	306.9	229.9	229.9	172.3
1500	0.028X	316.1	236.4	229.2	171.7	171.7	128.6
1000	0.423X	208.9	156.2	151.5	113.4	113.4	85.0
950	0.045X	198.2	148.2	143.7	107.6	107.6	80.6
900	0.047X	187.4	140.2	135.9	101.8	101.8	76.3
850	0.050X	176.7	132.2	128.1	96.0	96.0	71.9
800	0.053X	166.0	124.2	120.4	90.1	90.1	67.5
750	0.057X	155.3	116.1	112.6	84.3	84.3	63.2
700	0.061X	144.6	108.1	104.8	78.5	78.5	58.8
650	0.066X	133.8	100.1	97.0	72.7	72.7	54.5
600	0.072X	123.1	92.1	89.3	66.8	66.8	50.1
550	0.079X	112.4	84.1	81.5	61.0	61.0	45.7
500	0.087X	101.7	76.0	73.7	55.2	55.2	41.4
450	0.097X	90.9	68.0	65.9	49.4	49.4	37.0
400	0.110X	80.2	60.0	58.2	43.6	43.6	32.6
350	0.127X	69.5	52.0	50.4	37.7	37.7	28.3
300	0.151X	58.7	43.9	42.6	31.9	31.9	23.9
250	0.184X	48.0	35.9	34.8	26.1	26.1	19.5
200	0.238X	37.3	27.9	27.0	20.2	20.2	15.2
150	0.334X	26.5	19.8	19.2	14.4	14.4	10.8
140	0.363X	24.4	18.2	17.7	13.2	13.2	9.9

### TEC-M55 with 2X Converter

Working Distance (mm)	Optical Magnification	Field of View (mm)					
		2/3"		1/2"		1/3"	
		H	V	H	V	H	V
5000	0.019X	453.1	340.3	330.0	247.7	247.7	185.8
4000	0.024X	362.0	271.9	263.6	197.9	197.9	148.5
3000	0.032X	270.9	203.4	197.3	148.1	148.1	111.1
2000	0.049X	179.8	135.0	130.9	98.3	98.3	73.7
1500	0.065X	134.3	100.8	97.8	73.4	73.4	55.0
1000	0.098X	88.7	66.6	64.6	48.5	48.5	36.4
950	0.104X	84.1	63.2	61.3	46.0	46.0	34.5
900	0.110X	79.6	59.8	58.0	43.5	43.5	32.6
850	0.116X	75.0	56.3	54.6	41.0	41.0	30.8
800	0.124X	70.5	52.9	51.3	38.5	38.5	28.9
750	0.133X	65.9	49.5	48.0	36.0	36.0	27.0
700	0.142X	61.4	46.1	44.7	33.5	33.5	25.2
650	0.154X	56.8	42.7	41.4	31.0	31.0	23.3
600	0.167X	52.3	39.2	38.1	28.6	28.6	21.4
550	0.183X	47.7	35.8	34.7	26.1	26.1	19.6
500	0.203X	43.2	32.4	31.4	23.6	23.6	17.7
450	0.227X	38.6	29.0	28.1	21.1	21.1	15.8
400	0.257X	34.0	25.6	24.8	18.6	18.6	14.0
350	0.297X	29.5	22.1	21.5	16.1	16.1	12.1
300	0.352X	24.9	18.7	18.2	13.6	13.6	10.2
250	0.431X	20.4	15.3	14.8	11.1	11.1	8.4
200	0.558X	15.8	11.9	11.5	8.7	8.7	6.5
150	0.789X	11.3	8.5	8.2	6.2	6.2	4.6
140	0.861X	10.4	7.8	7.6	5.7	5.7	4.3

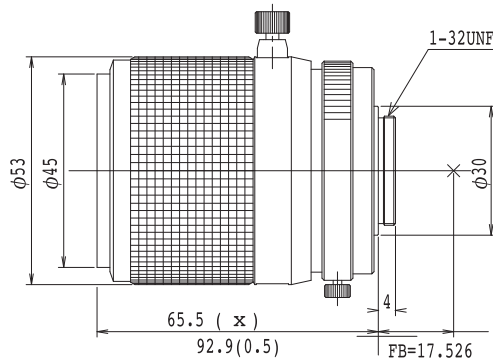

### 2X Converter

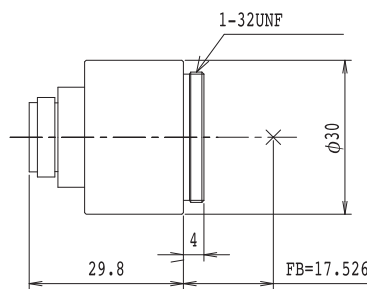

### 0.75X Converter

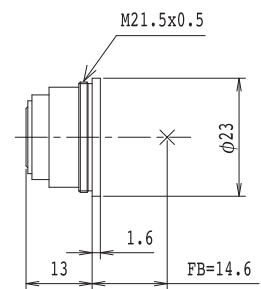



# 1.1" 12 MEGAPIXEL TELECENTRIC LENS

1.1" 12MP  
TELECENTRIC

- Compatible with 12MP (3.45μm) sensor on 1.1" cameras
- Variable F-stop (F5.0 ~ F32.4)

- Designed for a 165.2mm working distance
- Low TV distortion correction up to the outermost corner (-0.024%)

**NEW**

## TEC-V0345165MPY-WI

1.1"

12MP

TELECENTRIC



Model	TEC-V0345165MPY-WI
Format	1.1" φ 17.6mm
Magnification	0.345X
Working Distance	165.2mm
Resolving Power *1	9.7μm
Depth of Field *2	6.63mm
NA	0.035
Effective F-number	5.0
TV Distortion	-0.024

Field of View	1.1inch	41.1x30.1mm
	1inch	38.3x25.2mm
	2/3inch	25.5x19.1mm
	1/1.8inch	20.9x15.4mm
	1/2inch	18.6x13.9mm
Mount	C-mount	
Filter Size	M72xP0.75mm	
Weight	380g	

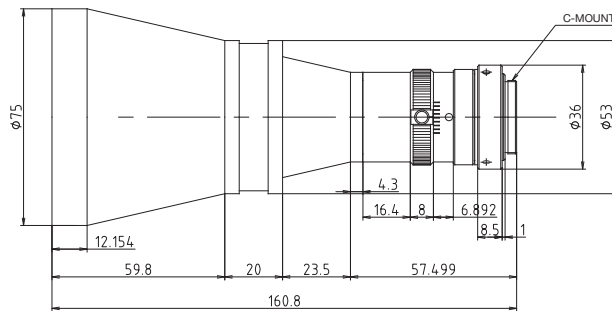

1" 5MP  
TELECENTRIC

# 1" 5 MEGAPIXEL TELECENTRIC LENS



- Compatible with 5MP sensors on 1" cameras
- Versatile four-lens lineup designed for 65mm and 110mm WD (working distance)

- 0.5x and 1.0x magnification options available
- Low TV distortion correction up to the outermost corner (0.01 ~ 0.02s%)

## WD-65mm

### TEC-V0565MPW

1"  
5MP  
TELECEM



Model	TEC-V0565MPW
Format	1" $\phi$ 16mm
Magnification	0.5x
Working Distance	65.2mm
Resolving Power *1	12 $\mu$ m
Depth of Field *2	2.88mm
NA	0.027
Effective F-number	9.0
TV Distortion	-0.014%

Field of View	1inch	25.6 x 19.2mm
	2/3inch	17.6 x 13.2mm
	1/1.8inch	14.4 x 10.8mm
	1/2inch	12.8 x 9.6mm
Mount	C-mount	
Weight	189g	

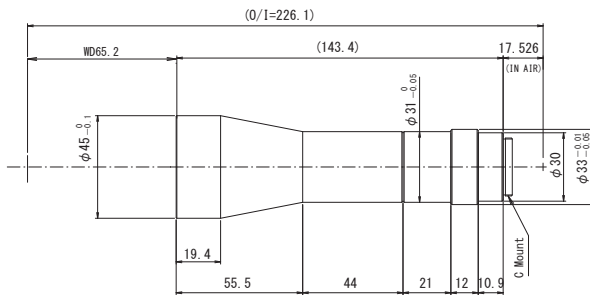

### TEC-V1065MPW

1"  
5MP  
TELECEM



Model	TEC-V1065MPW
Format	1" $\phi$ 16mm
Magnification	1x
Working Distance	65.2mm
Resolving Power *1	6 $\mu$ m
Depth of Field *2	0.72mm
NA	0.055
Effective F-number	9.0
TV Distortion	-0.023%

Field of View	1inch	12.8 x 9.6mm
	2/3inch	8.8 x 6.6mm
	1/1.8inch	7.2 x 5.4mm
	1/2inch	6.4 x 4.8mm
Mount	C-mount	
Weight	158g	

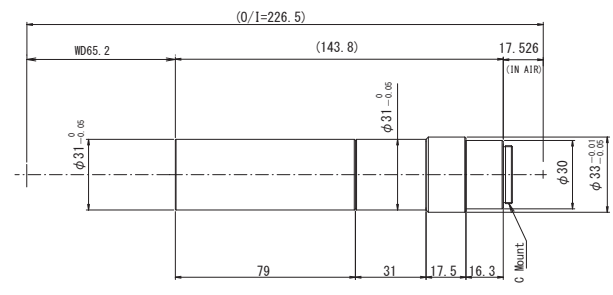

## WD-110mm

### TEC-V05110MPW

1"  
5MP  
TELECEM



Model	TEC-V05110MPW
Format	1" $\phi$ 16mm
Magnification	0.5x
Working Distance	110.2mm
Resolving Power *1	12 $\mu$ m
Depth of Field *2	2.88mm
NA	0.027
Effective F-number	9.0
TV Distortion	0.012%

Field of View	1inch	25.6 x 19.2mm
	2/3inch	17.6 x 13.2mm
	1/1.8inch	14.4 x 10.8mm
	1/2inch	12.8 x 9.6mm
Mount	C-mount	
Weight	197g	

\*Variable Iris type available.

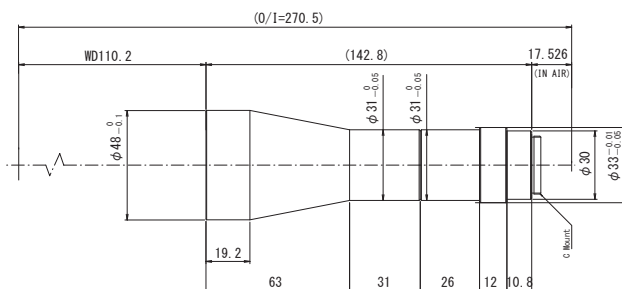

### TEC-V10110MPW

1"  
5MP  
TELECEM



Model	TEC-V10110MPW
Format	1" $\phi$ 16mm
Magnification	1x
Working Distance	110.2mm
Resolving Power *1	6 $\mu$ m
Depth of Field *2	0.72mm
NA	0.055
Effective F-number	9.0
TV Distortion	0.015%

Field of View	1inch	12.8 x 9.6mm
	2/3inch	8.8 x 6.6mm
	1/1.8inch	7.2 x 5.4mm
	1/2inch	6.4 x 4.8mm
Mount	C-mount	
Weight	159g	

\*Variable Iris type available.

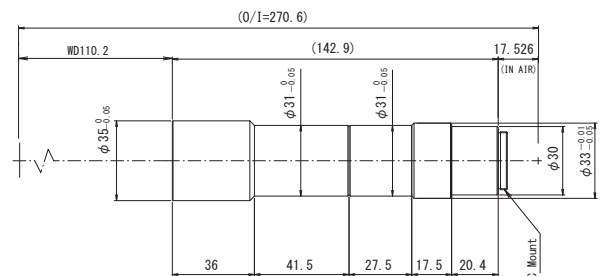





# 2/3" 2 MEGAPIXEL TELECENTRIC LENS

2/3" 2MP  
TELECENTRIC

- A wide variety of magnification options available:  
65mm WD - 0.5x, 0.8x, 1.0x, 2.0x, 4.0x, 6.0x  
110mm WD - 0.3x, 0.5x, 0.8x, 1.0x, 1.5x, 2.0x, 3.0x, 4.0x, 6.0x
- All models available with coax. lighting
- Compatible with 2MP sensors on 2/3" cameras
- Low TV distortion correction to the outermost corner (0.01 ~ 0.03%)

## WD-65mm

### TEC-M0565MPC / TEC-M0565MP

2/3"  
2MP  
TELECENTRIC



Model (with coaxial type)	TEC-M0565MPC
Model (straight type)	TEC-M0565MP
Format	2/3" φ 11mm
Magnification	0.5x
Working Distance	65.5mm
Resolving Power *1	12μm
Depth of Field *2	2.87mm
NA	0.028
Effective F-number	9.0
TV Distortion	-0.012%

Field of View	2/3inch	17.6 x 13.2mm
	1/1.8inch	14.35 x 10.64mm
	1/2inch	12.8 x 9.6mm
	1/3inch	9.6 x 7.2mm
Mount	C-mount	
Weight (with coaxial type)	80g	
Weight (straight type)	77g	

TEC-M0565MPC

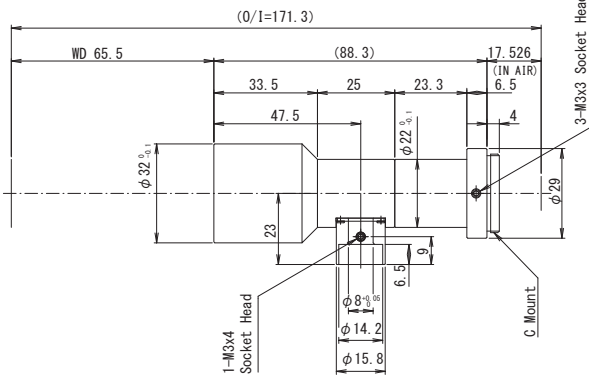

TEC-M0565MP

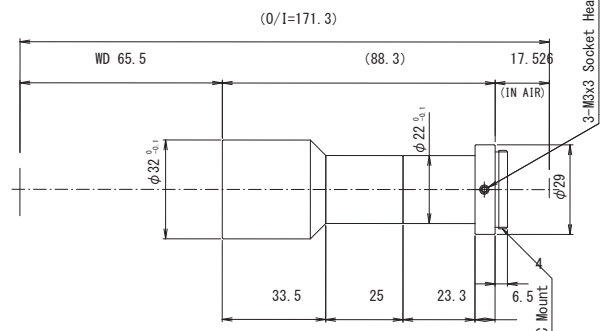

### TEC-M0865MPC / TEC-M0865MP

2/3"  
2MP  
TELECENTRIC



Model (with coaxial type)	TEC-M0865MPC
Model (straight type)	TEC-M0865MP
Format	2/3" φ 11mm
Magnification	0.8x
Working Distance	66mm
Resolving Power *1	8μm
Depth of Field *2	1.18mm
NA	0.042
Effective F-number	9.4
TV Distortion	0.008%

Field of View	2/3inch	11 x 8.25mm
	1/1.8inch	8.97 x 6.65mm
	1/2inch	8 x 6mm
	1/3inch	6 x 4.5mm
Mount	C-mount	
Weight (with coaxial type)	62g	
Weight (straight type)	57g	

TEC-M0865MPC

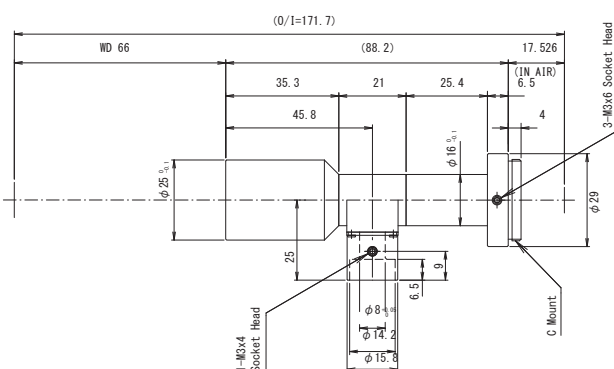

TEC-M0865MP

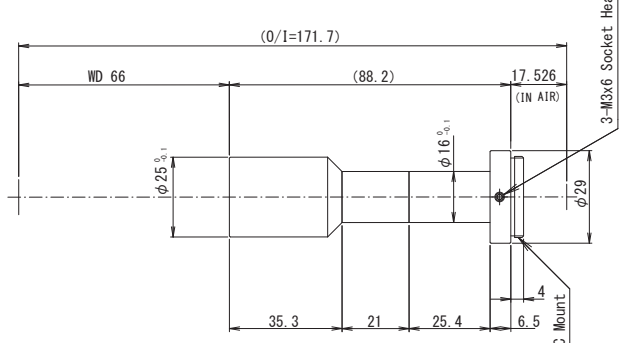

\*1: Theoretical resolution calculated with a wavelength of 550nm \*2: Value calculated with a permissible circle of confusion of 40μm

2/3" 2MP  
TELECENTRIC

## 2/3" 2 MEGAPIXEL TELECENTRIC LENS



- A wide variety of magnification options available:  
65mm WD - 0.5x, 0.8x, 1.0x, 2.0x, 4.0x, 6.0x  
110mm WD - 0.3x, 0.5x, 0.8x, 1.0x, 1.5x, 2.0x, 3.0x, 4.0x, 6.0x
- All models available with coax. lighting

- Compatible with 2MP sensors on 2/3" cameras
- Low TV distortion correction to the outermost corner (0.01 ~ 0.03s%)

### WD-65mm

#### TEC-M1065MPC / TEC-M1065MP

2/3"  
2MP  
TELECENT



Model (with coaxial type)	TEC-M1065MPC
Model (straight type)	TEC-M1065MP
Format	2/3" φ 11mm
Magnification	1x
Working Distance	65.5mm
Resolving Power *1	6.7μm
Depth of Field *2	0.79mm
NA	0.05
Effective F-number	9.8
TV Distortion	-0.022%

Field of View	2/3inch	8.8 x 6.6mm
	1/1.8inch	7.18 x 5.32mm
	1/2inch	6.4 x 4.8mm
	1/3inch	4.8 x 3.6mm
Mount	C-mount	
Weight (with coaxial type)	54g	
Weight (straight type)	49g	

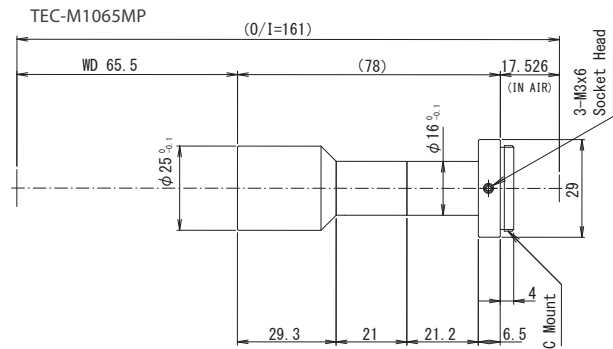
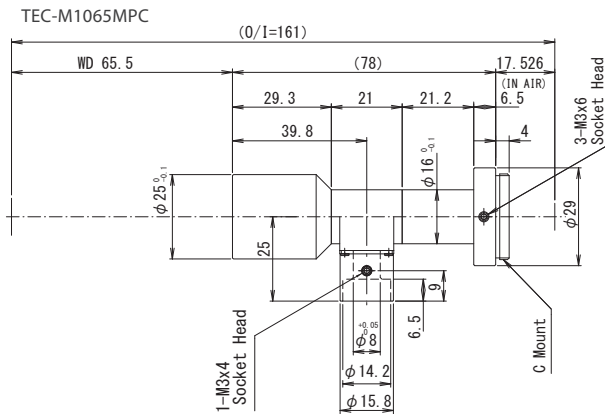

#### TEC-M2065MPC / TEC-M2065MP

2/3"  
2MP  
TELECENT



Model (with coaxial type)	TEC-M2065MPC
Model (straight type)	TEC-M2065MP
Format	2/3" φ 11mm
Magnification	2x
Working Distance	65.4mm
Resolving Power *1	4.4μm
Depth of Field *2	0.26mm
NA	0.076
Effective F-number	12.8
TV Distortion	0.020%

Field of View	2/3inch	4.4 x 3.3mm
	1/1.8inch	3.59 x 2.66mm
	1/2inch	3.2 x 2.4mm
	1/3inch	2.4 x 1.8mm
Mount	C-mount	
Weight (with coaxial type)	55g	
Weight (straight type)	49g	

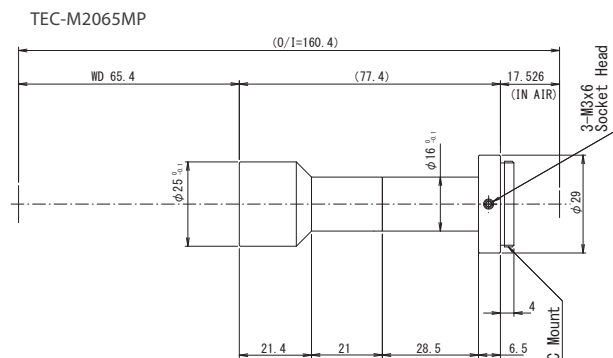
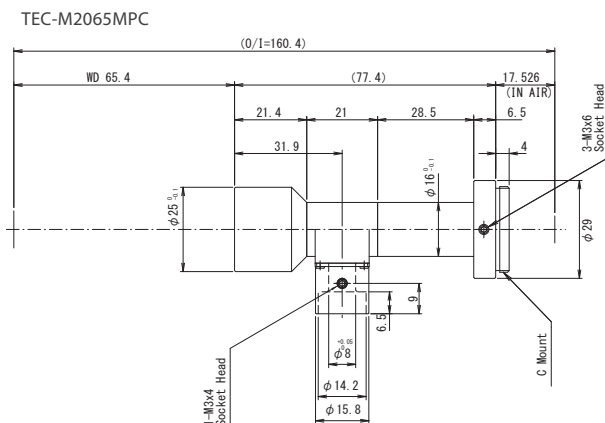



# 2/3" 2 MEGAPIXEL TELECENTRIC LENS



WD-65mm

## TEC-M4065MPC / TEC-M4065MP

2/3"  
2MP  
TELECEM



Model (with coaxial type)	TEC-M4065MPC
Model (straight type)	TEC-M4065MP
Format	2/3" $\phi$ 12.8mm
Magnification	4.0x
Working Distance	65.3mm
Resolving Power *1	2.9 $\mu$ m
Depth of Field *2	0.08mm
NA	0.118
Effective F-number	16.9
TV Distortion	-0.003%

Field of View	2/3inch	2.2 x 1.65mm
	1/1.8inch	1.79 x 1.33mm
	1/2inch	1.6 x 1.2mm
Mount	1/3inch	1.2 x 0.9mm
		C-mount
Weight (with coaxial type)		85g
Weight (straight type)		83g

TEC-M4065MPC

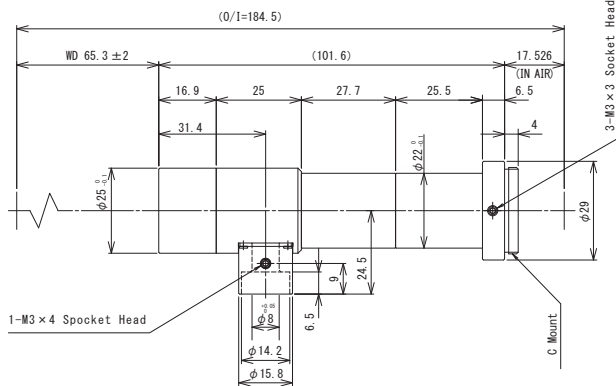

TEC-M4065MP

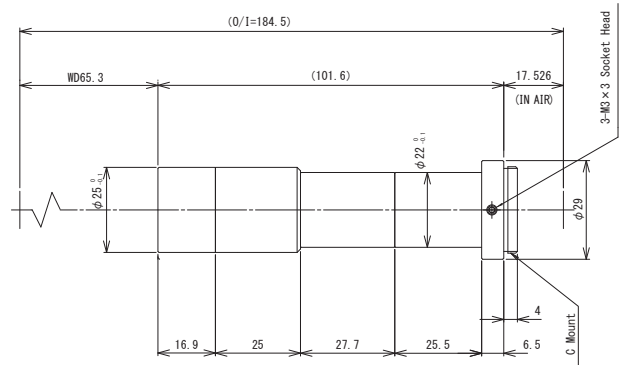

## TEC-M6065MPC / TEC-M6065MP

2/3"  
2MP  
TELECEM



Model (with coaxial type)	TEC-M6065MPC
Model (straight type)	TEC-M6065MP
Format	2/3" $\phi$ 12.8mm
Magnification	6.0x
Working Distance	64.0mm
Resolving Power *1	2.9 $\mu$ m
Depth of Field *2	0.06mm
NA	0.118
Effective F-number	25.5
TV Distortion	-0.026%

Field of View	2/3inch	1.47 x 1.1mm
	1/1.8inch	1.2 x 0.89mm
	1/2inch	1.07 x 0.8mm
Mount	1/3inch	0.8 x 0.6mm
		C-mount
Weight (with coaxial type)		100g
Weight (straight type)		98g

TEC-M6065MPC

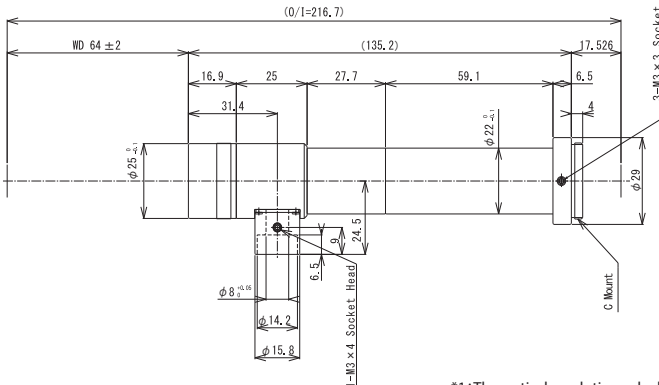

TEC-M6065MP

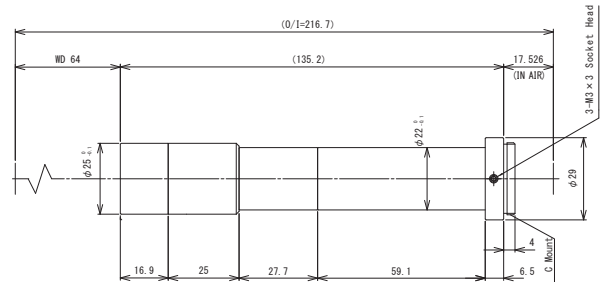

\*1: Theoretical resolution calculated with a wavelength of 550nm \*2: Value calculated with a permissible circle of confusion of 40 $\mu$ m

2/3" 2MP  
TELECENTRIC

## 2/3" 2 MEGAPIXEL TELECENTRIC LENS



- A wide variety of magnification options available:  
65mm WD - 0.5x, 0.8x, 1.0x, 2.0x, 4.0x, 6.0x  
110mm WD - 0.3x, 0.5x, 0.8x, 1.0x, 1.5x, 2.0x, 3.0x, 4.0x, 6.0x
- All models available with coax. lighting

- Compatible with 2MP sensors on 2/3" cameras
- Low TV distortion correction to the outermost corner (0.01 ~ 0.03s%)

### WD-110mm

#### TEC-M03110MPC / TEC-M03110MP

2/3"  
2MP  
TELECENTRIC



Model (with coaxial type)	TEC-M03110MPC
Model (straight type)	TEC-M03110MP
Format	2/3" φ 11mm
Magnification	0.3x
Working Distance	111mm
Resolving Power *1	14.5μm
Depth of Field *2	5.75mm
NA	0.023
Effective F-number	6.5
TV Distortion	0.026%

Field of View	2/3inch	29.3 x 22mm
	1/1.8inch	23.9 x 17.7mm
	1/2inch	21.3 x 16mm
Mount	1/3inch	16 x 12mm
		C-mount
Weight (with coaxial type)		166g
Weight (straight type)		160g

TEC-M03110MPC

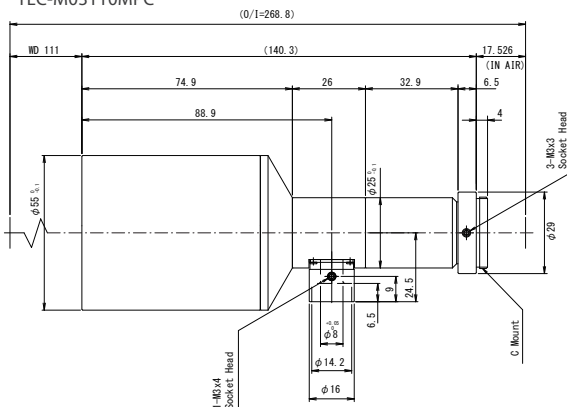

TEC-M03110MP

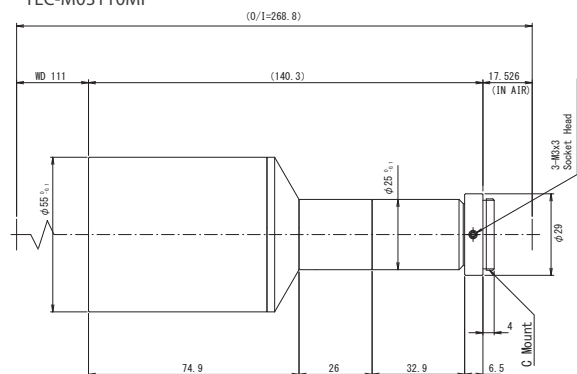

#### TEC-M05110MPC / TEC-M05110MP

2/3"  
2MP  
TELECENTRIC



Model (with coaxial type)	TEC-M05110MPC
Model (straight type)	TEC-M05110MP
Format	2/3" φ 11mm
Magnification	0.5x
Working Distance	111.8mm
Resolving Power *1	12.7μm
Depth of Field *2	3.03mm
NA	0.026
Effective F-number	9.4
TV Distortion	-0.009%

Field of View	2/3inch	17.6 x 13.2mm
	1/1.8inch	14.35 x 10.64mm
	1/2inch	12.8 x 9.6mm
Mount	1/3inch	9.6 x 7.2mm
		C-mount
Weight (with coaxial type)		131g
Weight (straight type)		128g

TEC-M05110MPC

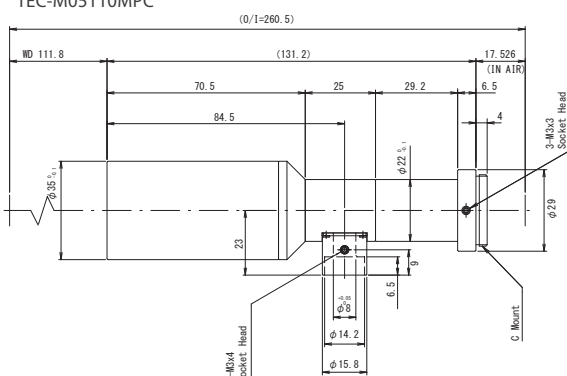

TEC-M05110MP

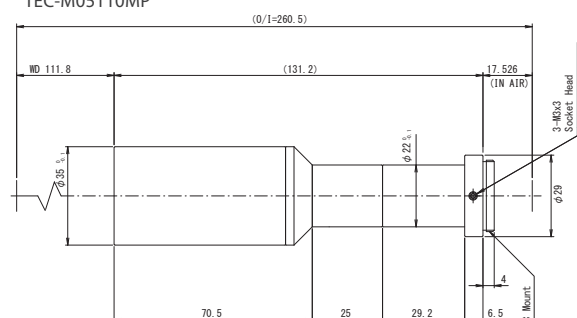



# 2/3" 2 MEGAPIXEL TELECENTRIC LENS

2/3" 2MP  
TELECENTRIC

WD-110mm

## TEC-M08110MPC / TEC-M08110MP

2/3"  
2MP  
TELECENTRIC



Model (with coaxial type)	TEC-M08110MPC
Model (straight type)	TEC-M08110MP
Format	2/3" $\phi$ 11mm
Magnification	0.8x
Working Distance	111mm
Resolving Power *1	8.8 $\mu$ m
Depth of Field *2	1.31mm
NA	0.038
Effective F-number	10.2
TV Distortion	-0.027%

Field of View	2/3inch	11 x 8.25mm
	1/1.8inch	8.97 x 6.65mm
	1/2inch	8 x 6mm
Mount	1/3inch	6 x 4.5mm
	C-mount	
Weight (with coaxial type)		106g
Weight (straight type)		103g

TEC-M08110MPC

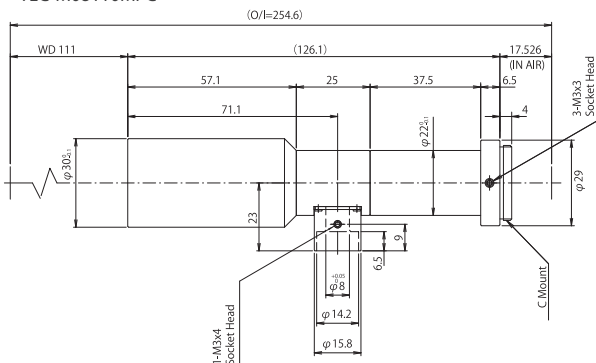

TEC-M08110MP

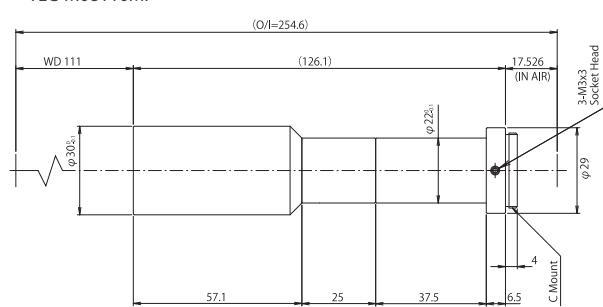

## TEC-M10110MPC / TEC-M10110MP

2/3"  
2MP  
TELECENTRIC



Model (with coaxial type)	TEC-M10110MPC
Model (straight type)	TEC-M10110MP
Format	2/3" $\phi$ 11mm
Magnification	1x
Working Distance	111.5mm
Resolving Power *1	6.9 $\mu$ m
Depth of Field *2	0.82mm
NA	0.049
Effective F-number	10.1
TV Distortion	-0.003%

Field of View	2/3inch	8.8 x 6.6mm
	1/1.8inch	7.18 x 5.32mm
	1/2inch	6.4 x 4.8mm
Mount	1/3inch	4.8 x 3.6mm
	C-mount	
Weight (with coaxial type)		108g
Weight (straight type)		105g

TEC-M10110MPC

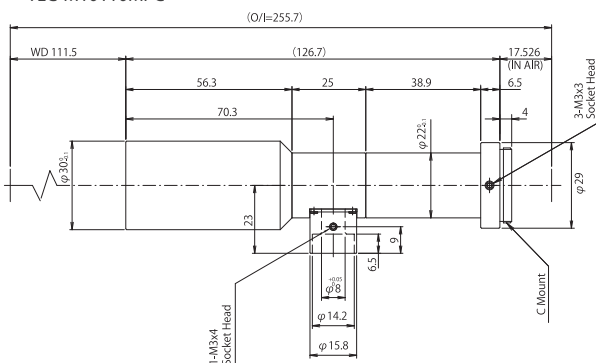

TEC-M10110MP

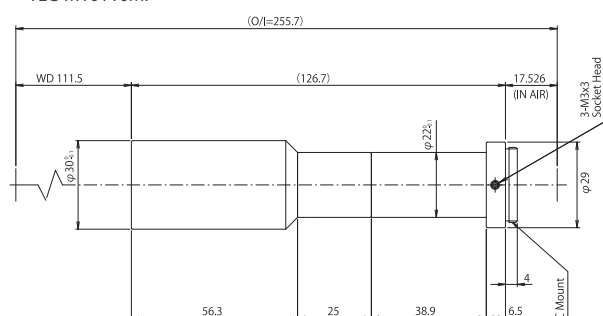

\*1: Theoretical resolution calculated with a wavelength of 550nm \*2: Value calculated with a permissible circle of confusion of 40 $\mu$ m

2/3" 2MP  
TELECENTRIC

## 2/3" 2 MEGAPIXEL TELECENTRIC LENS



- A wide variety of magnification options available:  
65mm WD - 0.5x, 0.8x, 1.0x, 2.0x, 4.0x, 6.0x  
110mm WD - 0.3x, 0.5x, 0.8x, 1.0x, 1.5x, 2.0x, 3.0x, 4.0x, 6.0x
- All models available with coax. lighting

- Compatible with 2MP sensors on 2/3" cameras
- Low TV distortion correction to the outermost corner (0.01 ~ 0.03s%)

### WD-110mm

#### TEC-M15110MPC / TEC-M15110MP

2/3"  
2MP  
TELECENTRIC



Model (with coaxial type)	TEC-M15110MPC
Model (straight type)	TEC-M15110MP
Format	2/3" φ 11mm
Magnification	1.5x
Working Distance	110.7mm
Resolving Power *1	5.2μm
Depth of Field *2	0.42mm
NA	0.064
Effective F-number	11.5
TV Distortion	0.031%

Field of View	2/3inch	5.87 x 4.4mm
	1/1.8inch	4.79 x 3.55mm
	1/2inch	4.27 x 3.2mm
	1/3inch	3.2 x 2.4mm
Mount	C-mount	
Weight (with coaxial type)	110g	
Weight (straight type)	108g	

TEC-M15110MPC

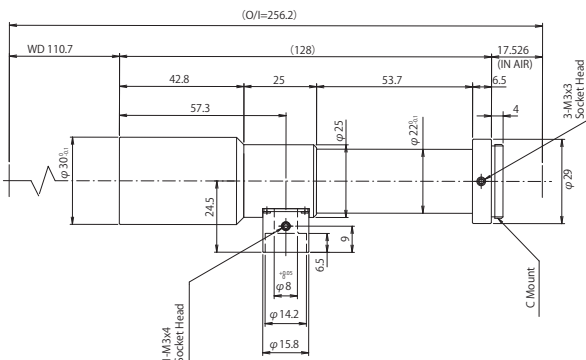

TEC-M15110MP

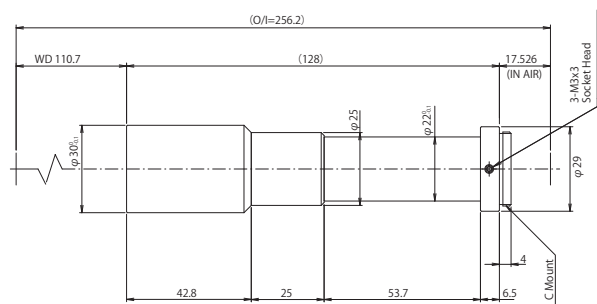

#### TEC-M20110MPC / TEC-M20110MP

2/3"  
2MP  
TELECENTRIC



Model (with coaxial type)	TEC-M20110MPC
Model (straight type)	TEC-M20110MP
Format	2/3" φ 11mm
Magnification	2x
Working Distance	110.9mm
Resolving Power *1	4.5μm
Depth of Field *2	0.27mm
NA	0.075
Effective F-number	13.0
TV Distortion	-0.019%

Field of View	2/3inch	4.4 x 3.3mm
	1/1.8inch	3.59 x 2.66mm
	1/2inch	3.2 x 2.4mm
	1/3inch	2.4 x 1.8mm
Mount	C-mount	
Weight (with coaxial type)	115g	
Weight (straight type)	113g	

TEC-M20110MPC

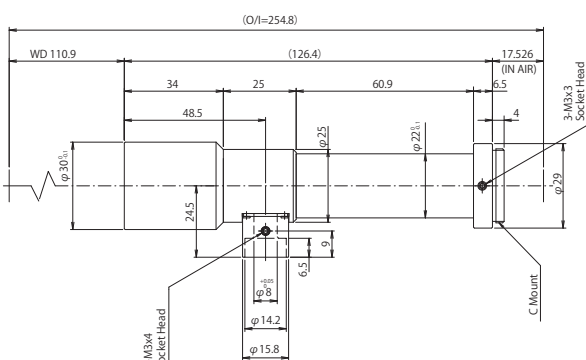

TEC-M20110MP

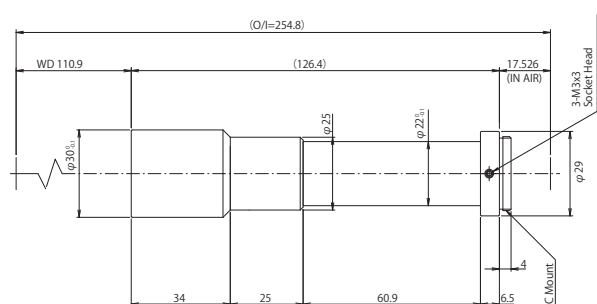



# 2/3" 2 MEGAPIXEL TELECENTRIC LENS

2/3" 2MP  
TELECENTRIC

WD-110mm

## TEC-M30110MPC / TEC-M30110MP



2/3"

2MP

TELECENTRIC

Model (with coaxial type)	TEC-M30110MPC
Model (straight type)	TEC-M30110MP
Format	2/3" $\phi$ 12.8mm
Magnification	3.0x
Working Distance	111.4mm
Resolving Power *1	3.6 $\mu$ m
Depth of Field *2	0.14mm
NA	0.094
Effective F-number	16.0
TV Distortion	-0.012%

Field of View	2/3inch	2.93 x 2.2mm
	1/1.8inch	2.39 x 1.77mm
	1/2inch	2.13 x 1.6mm
Mount	1/3inch	1.6 x 1.2mm
		C-mount
Weight (with coaxial type)		166g
Weight (straight type)		160g

TEC-M30110MPC

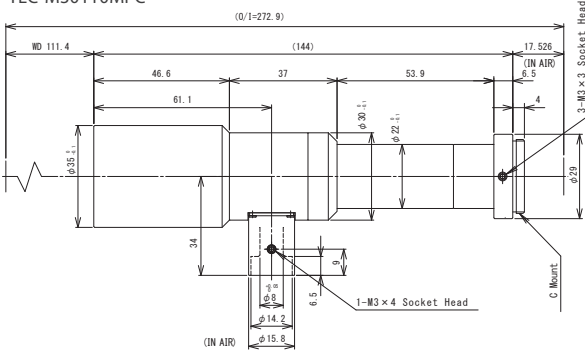

TEC-M30110MP

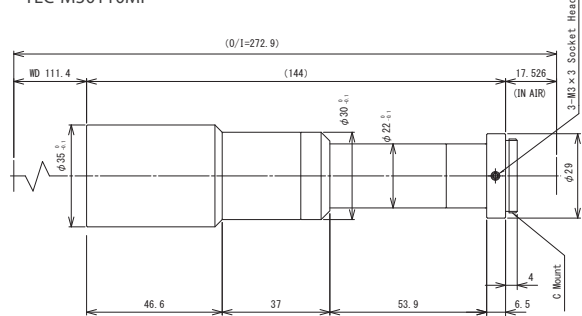

## TEC-M40110MPC / TEC-M40110MP



2/3"

2MP

TELECENTRIC

Model (with coaxial type)	TEC-M40110MPC
Model (straight type)	TEC-M40110MP
Format	2/3" $\phi$ 11mm
Magnification	4.0x
Working Distance	110.5mm
Resolving Power *1	3.7 $\mu$ m
Depth of Field *2	0.11mm
NA	0.091
Effective F-number	21.9
TV Distortion	-0.004%

Field of View	2/3inch	2.2 x 1.65mm
	1/1.8inch	1.79 x 1.33mm
	1/2inch	1.6 x 1.2mm
Mount	1/3inch	1.2 x 0.9mm
		C-mount
Weight (with coaxial type)		121g
Weight (straight type)		120g

TEC-M40110MPC

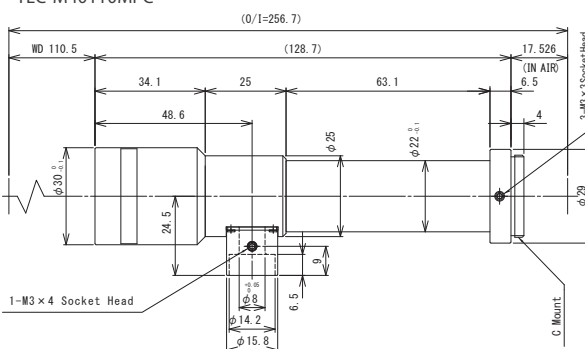

TEC-M40110MP

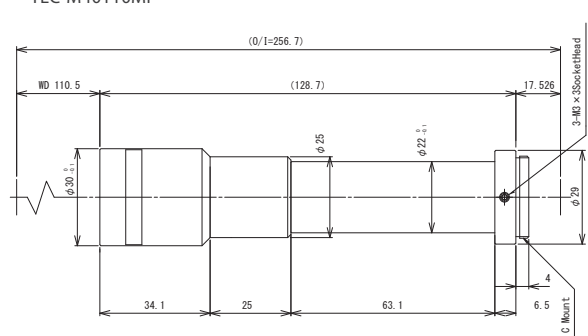

\*1: Theoretical resolution calculated with a wavelength of 550nm \*2: Value calculated with a permissible circle of confusion of 40 $\mu$ m



- A wide variety of magnification options available:  
65mm WD - 0.5x, 0.8x, 1.0x, 2.0x, 4.0x, 6.0x  
110mm WD - 0.3x, 0.5x, 0.8x, 1.0x, 1.5x, 2.0x, 3.0x, 4.0x, 6.0x
- All models available with coax. lighting
- Compatible with 2MP sensors on 2/3" cameras
- Low TV distortion correction to the outermost corner (0.01 ~ 0.03s%)

## WD-110mm

### TEC-M60110MPC / TEC-M60110MP

2/3"  
2MP  
TELECENTRIC



Model (with coaxial type)	TEC-M60110MPC
Model (straight type)	TEC-M60110MP
Format	2/3" φ 12.8mm
Magnification	6.0x
Working Distance	110mm
Resolving Power *1	4.4μm
Depth of Field *2	0.09mm
NA	0.076
Effective F-number	39.6
TV Distortion	-0.015%

Field of View	2/3inch	1.5 x 1.1mm
	1/1.8inch	1.2 x 0.9mm
	1/2inch	1.1 x 0.8mm
Mount	1/3inch	0.8 x 0.6mm
		C-mount
Weight (with coaxial type)		103g
Weight (straight type)		101g

TEC-M60110MPC

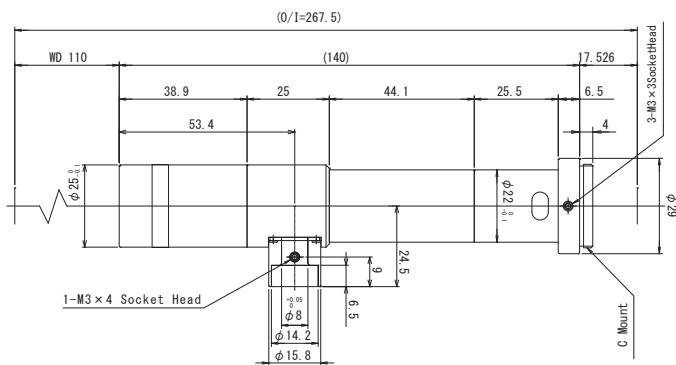

TEC-M60110MP

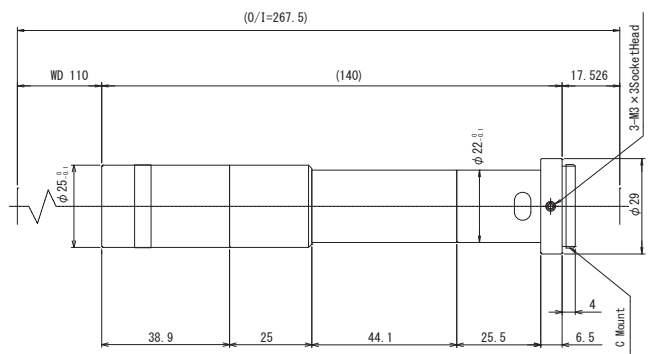





# ACCESSORIES



MODEL NO.	EX1.5CS
Description	1.5X Extender for CS-mount
Application	Attached between lens and camera - Makes focal length 1.5X

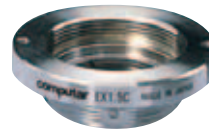

MODEL NO.	EX1.5C
Description	1.5X Extender for C-mount
Application	Attached between lens and camera - Makes focal length 1.5X



MODEL NO.	EX2CS
Description	2X Extender for CS-mount
Application	Attached between lens and camera - Makes focal length 2X



MODEL NO.	EX2C
Description	2X Extender for C-mount
Application	Attached between lens and camera - Makes focal length 2X



MODEL NO.	VM100
Description	Extension Tube Kit 40, 20, 10, 5, 1, 0.5mm
Application	Attached between lens and camera - Reduces minimum focusing distance



MODEL NO.	VM400
Description	5mm Adapter Ring
Application	Attached between lens and camera - Adapts C-mount lens to CS-mount camera



MODEL NO.	M55-0.75X
Description	Rear converter 0.75X (Designed for TEC-M55)
Application	Makes focal length 0.75X



MODEL NO.	M55-2.0X
Description	Rear converter 2.0X (Designed for TEC-M55)
Application	Makes focal length 2.0X



MODEL NO.	VM0811
Description	Filter holder for V0828-MPY2 (M72 P=0.75)
Application	Attached between filter and lens for 1.1" sensor camera



MODEL NO.	VM0810
Description	Filter holder for V0828-MPY2 (M67 P=0.75)
Application	Attached between filter and lens for 1" sensor camera



MODEL NO.	ZM0810
Description	Filter holder for V0826-MPZ (M82 P=0.75)
Application	Attached between filter and lens for 1" sensor camera



# SWIR (Short-Wave Infrared) LENS



- Designed for SWIR (800-1700nm) range
- Compact & light weight

- Fast F-stop
- Covers 640 x 512, 15µm sensor

## M1614-SW

- 2/3"
- SWIR
- FIX
- MANUAL



Focal Length	16mm		
Max. Aperture Ratio	1:1.4		
Max. Image Circle	φ 12.3mm		
Operation Range	Iris	F1.4 - F16C	
	Focus	0.3m - Inf.	
Control	Iris	Manual	
	Focus	Manual	
Angle of View	H	2/3"	37.7°
		1/2"	27.9°
		V	16.9°
Operating Temperature	-10° C ~ +50° C		

Optical Distortion	2/3"	-0.5% (y=5.5)	1/2"	-0.5% (y=4.0)
Back Focal Length	13.3mm (Inf)			
Flange Back Length	17.526mm			
Mount	C-Mount			
Filter Size	M30.5 P=0.5mm			
Dimensions	φ 33.5mm x 28.2mm			
Weight	60g			

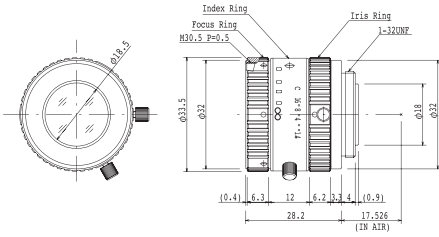

Angle of View (InGaAs Detector)	D	640 x 512 (Pixel Pitch : 15µm)	41.7°	320 x 256 (Pixel Pitch : 25µm)	35.3°	320 x 256 (Pixel Pitch : 20µm)	28.6°
	H	H9.60mm x V7.68mm	33.2°	H8.00mm x V6.40mm	27.9°	H6.40mm x V5.12mm	22.5°
	V		26.8°		22.5°		18.0°

## M2514-SW

- 2/3"
- SWIR
- FIX
- MANUAL



Focal Length	25mm		
Max. Aperture Ratio	1:1.4		
Max. Image Circle	φ 12.3mm		
Operation Range	Iris	F1.4 - F16C	
	Focus	0.3m - Inf.	
Control	Iris	Manual	
	Focus	Manual	
Angle of View	H	2/3"	24.7°
		1/2"	18.1°
		V	10.9°
Operating Temperature	-10° C ~ +50° C		

Optical Distortion	2/3"	-0.5% (y=5.5)	1/2"	-0.2% (y=4.0)
Back Focal Length	13.4mm (Inf)			
Flange Back Length	17.526mm			
Mount	C-Mount			
Filter Size	M30.5 P=0.5mm			
Dimensions	φ 33.5mm x 36.0mm			
Weight	71.2g			

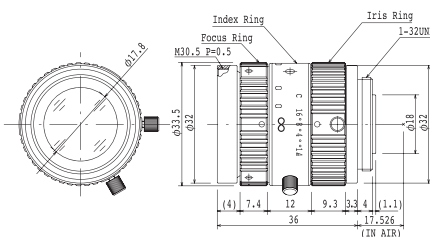

Angle of View (InGaAs Detector)	D	640 x 512 (Pixel Pitch : 15µm)	27.6°	320 x 256 (Pixel Pitch : 25µm)	23.0°	320 x 256 (Pixel Pitch : 20µm)	18.5°
	H	H9.60mm x V7.68mm	21.6°	H8.00mm x V6.40mm	18.1°	H6.40mm x V5.12mm	14.5°
	V		17.3°		14.5°		11.6°



# SWIR (Short-Wave Infrared) LENS



- Designed for SWIR (800-1700nm) range
- Compact & light weight

- Fast F-stop
- Covers 640 x 512, 15μm sensor

## M3514-SW

- 2/3"
- SWIR
- FIX
- MANUAL

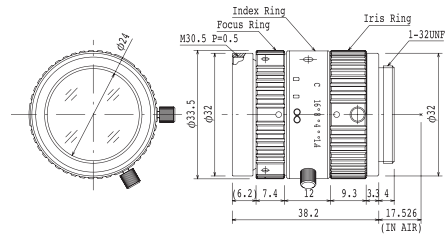

Focal Length	35mm		
Max. Aperture Ratio	1:1.4		
Max. Image Circle	φ 12.3mm		
Operation Range	Iris	F1.4 - F16C	
	Focus	0.3m - Inf.	
Control	Iris	Manual	
	Focus	Manual	
Angle of View	D	18.4°	13.4°
	H	2/3" 14.7°	1/2" 10.7°
	V	11.1°	8.1°
Operating Temperature	-10° C ~ +50° C		

Optical Distortion	2/3"	-0.1% (y=5.5)	1/2"	-0% (y=4.0)
Back Focal Length	14.6mm			
Flange Back Length	17.526mm			
Mount	C-Mount			
Filter Size	M30.5 P=0.5mm			
Dimensions	φ 33.5mm x 38.2mm			
Weight	87g			

Angle of View (InGaAs Detector)	D	640 x 512	20.5°	320 x 256	17.1°	320 x 256	13.7°
	H	(Pixel Pitch : 15μm)	16.0°	(Pixel Pitch : 25μm)	13.4°	(Pixel Pitch : 20μm)	10.7°
	V	H9.60mm x V7.68mm	12.9°	H8.00mm x V6.40mm	10.7°	H6.40mm x V5.12mm	8.6°

## M5018-SW

- 2/3"
- SWIR
- FIX
- MANUAL

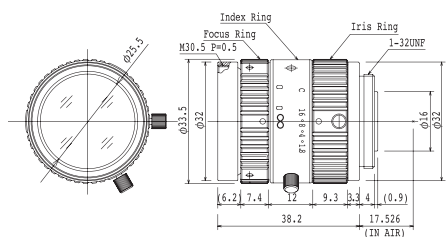

Focal Length	50mm		
Max. Aperture Ratio	1:1.8		
Max. Image Circle	φ 12.3mm		
Operation Range	Iris	F1.8 - F16C	
	Focus	0.6m - Inf.	
Control	Iris	Manual	
	Focus	Manual	
Angle of View	D	13.0°	9.5°
	H	2/3" 10.4°	1/2" 7.6°
	V	7.8°	5.7°
Operating Temperature	-10° C ~ +50° C		

Optical Distortion	2/3"	-0.3% (y=5.5)	1/2"	-0.1% (y=4.0)
Back Focal Length	13.6mm			
Flange Back Length	17.526mm			
Mount	C-Mount			
Filter Size	M30.5 P=0.5mm			
Dimensions	φ 33.5mm x 38.2mm			
Weight	85g			

Angle of View (InGaAs Detector)	D	640 x 512	14.5°	320 x 256	12.1°	320 x 256	9.7°
	H	(Pixel Pitch : 15μm)	11.3°	(Pixel Pitch : 25μm)	9.5°	(Pixel Pitch : 20μm)	7.6°
	V	H9.60mm x V7.68mm	9.1°	H8.00mm x V6.40mm	7.6°	H6.40mm x V5.12mm	6.1°

2/3" 5MP  
ITS

## 2/3" IR CORRECTIVE 5 MEGAPIXEL Lens for ITS



- Manual and P-Iris available
- 25, 35, 50mm 3 lens series

- High resolution for 5MP sensors
- IR corrected

### M2514FIC-MPIR

- 2/3"
- 5MP
- IR
- FIX
- MANUAL



Focal Length	25mm				
Max. Aperture Ratio	1:1.4				
Max. Image Format	11.3mm x 6.0mm (φ12.8mm)				
Operation Range	Iris	F1.4 - F16C			
	Focus	1.0m - Inf.			
Control	Iris	Manual			
	Focus	Manual			
Angle of View	D	CMV2000 11.264 x 5.984 (φ12.75)	28.6°	24.9°	18.2°
	H		25.4°	20.0°	14.6°
	V		13.7°	15.1°	11.0°
Operating Temperature	-10°C ~ +50°C				

Back Focal Length	10.8mm
Flange Back Length	17.526mm
Mount	C-Mount
Filter Size	M40.5 P=0.5mm
Dimensions	φ46.5mm x 53.9mm
Weight	154.2g

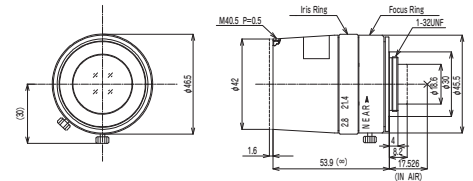

### M3518FIC-MPIR

- 2/3"
- 5MP
- IR
- FIX
- MANUAL



Focal Length	35mm				
Max. Aperture Ratio	1:1.8				
Max. Image Format	11.3mm x 6.0mm(φ12.8mm)				
Operation Range	Iris	F1.8 - F16C			
	Focus	1.0m - Inf.			
Control	Iris	Manual			
	Focus	Manual			
Angle of View	D	CMV2000 11.264 x 5.984 (φ12.75)	20.0°	17.4°	12.7°
	H		17.8°	13.9°	10.2°
	V		9.5°	10.5°	7.6°
Operating Temperature	-10°C ~ +50°C				

Back Focal Length	12.1mm
Flange Back Length	17.526mm
Mount	C-Mount
Filter Size	M40.5 P=0.5mm
Dimensions	φ46.5mm x 53.2mm
Weight	149.2g

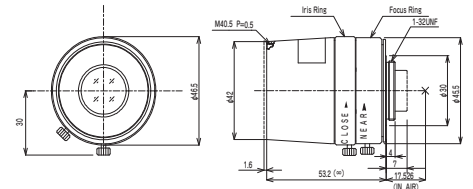

### M5020FIC-MPIR

- 2/3"
- 5MP
- IR
- FIX
- MANUAL



Focal Length	50mm				
Max. Aperture Ratio	1:2.0				
Max. Image Format	11.3mm x 6.0mm(φ12.8mm)				
Operation Range	Iris	F2.0 - F16C			
	Focus	2.0m - Inf.			
Control	Iris	Manual			
	Focus	Manual			
Angle of View	D	CMV2000 11.264 x 5.984 (φ12.75)	14.1°	12.2°	8.9°
	H		12.5°	9.8°	7.1°
	V		6.7°	7.3°	5.3°
Operating Temperature	-10°C ~ +50°C				

Back Focal Length	14.8mm
Flange Back Length	17.526mm
Mount	C-Mount
Filter Size	M40.5 P=0.5mm
Dimensions	φ46.5mm x 53.9mm
Weight	155.0g

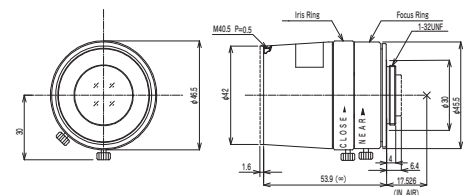



# 2/3" IR CORRECTIVE 5 MEGAPIXEL Lens for ITS

2/3" 5MP  
ITS

## MG2514KC-MPIR

- 2/3"
- 5MP
- IR
- FIX
- P-iris



Focal Length	25mm				
Max. Aperture Ratio	1:1.4				
Max. Image Format	11.3mm x 6.0mm (φ12.8mm)				
Operation Range	Iris	F1.4 - F16C			
	Focus	1.0m - Inf.			
Control	Iris	Stepping Motor			
	Focus	Manual			
Angle of View	D	CMV2000 11.264 x 5.984 (φ12.75)	28.6°	24.9°	18.2°
	H		25.4°	2/3" 20.0°	1/2" 14.6°
	V		13.7°	15.1°	11.0°
Operating Temperature	-10°C ~ +50°C				

Back Focal Length	10.8mm
Flange Back Length	17.526mm
Mount	C-Mount
Filter Size	M40.5 P=0.5mm
Dimensions	φ42mm x 58.6mm x 53.9mm
Weight	128.8g

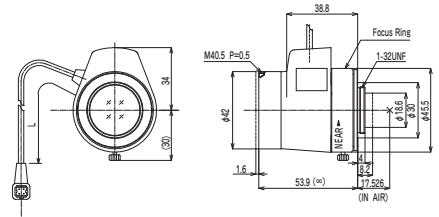

## MG3518KC-MPIR

- 2/3"
- 5MP
- IR
- FIX
- P-iris



Focal Length	35mm				
Max. Aperture Ratio	1:1.8				
Max. Image Format	11.3mm x 6.0mm(φ12.8mm)				
Operation Range	Iris	F1.8 - F16C			
	Focus	1.0m - Inf.			
Control	Iris	Stepping Motor			
	Focus	Manual			
Angle of View	D	CMV2000 11.264 x 5.984 (φ12.75)	20.0°	17.4°	12.7°
	H		17.8°	2/3" 13.9°	1/2" 10.2°
	V		9.5°	10.5°	7.6°
Operating Temperature	-10°C ~ +50°C				

Back Focal Length	12.1mm
Flange Back Length	17.526mm
Mount	C-Mount
Filter Size	M40.5 P=0.5mm
Dimensions	φ42mm x 56.8mm x 53.2mm
Weight	123g

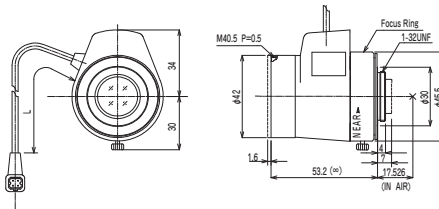

## MG5020KC-MPIR

- 2/3"
- 5MP
- IR
- FIX
- P-iris



Focal Length	50mm				
Max. Aperture Ratio	1:2.0				
Max. Image Format	11.3mm x 6.0mm(φ12.8mm)				
Operation Range	Iris	F2.0 - F16C			
	Focus	2.0m - Inf.			
Control	Iris	Stepping Motor			
	Focus	Manual			
Angle of View	D	CMV2000 11.264 x 5.984 (φ12.75)	14.1°	12.2°	8.9°
	H		12.5°	2/3" 9.8°	1/2" 7.1°
	V		6.7°	7.3°	5.3°
Operating Temperature	-10°C ~ +50°C				

Back Focal Length	14.8mm
Flange Back Length	17.526mm
Mount	C-Mount
Filter Size	M40.5 P=0.5mm
Dimensions	φ42mm x 56.8mm x 53.9mm
Weight	129g

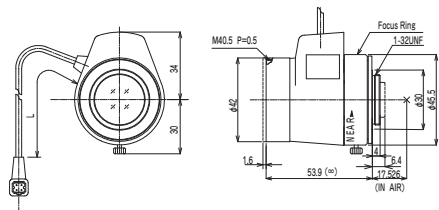



## 4K BOARD LENS

1/1.8" 4K IR FIX BOARD

• Compatible with 1/1.8" sensor • IR corrected • 4K ultra-high resolution



E3828KRW



E5228KRW

No.	Model Name	Format Inch	Mount	Pitch	Focal Length (mm)	Aperture (F)	Angle of view at Inf. (degrees)			Angle of view at Inf. (degrees)			Angle of view at Inf. (degrees)		
							1/1.8"			1/2"			1/3"		
							D	H	V	D	H	V	D	H	V
1	E3828KRW	1/1.8	M12	0.5	3.8mm	F2.8	133	107	80.7	120	96.2	72.4	90.3	72.4	54.3
2	E5228KRW	1/1.8	M12	0.5	5.2mm	F2.8	100	78.6	58.2	89.0	70.1	52.0	65.5	52.0	38.8

## 2 MEGAPIXEL BOARD LENS

1/2.8" 2MP FIX BOARD

• Compatible with 1/2.8" sensor • Metal housing



T2820KF3P

No.	Model Name	Format Inch	Mount	Pitch	Focal Length (mm)	Aperture (F)	Angle of view at Inf. (degrees)			Angle of view at Inf. (degrees)			Angle of view at Inf. (degrees)			IRCF
							1/2.8"			1/3"			1/4"			
							D	H	V	D	H	V	D	H	V	
1	T2820KP	1/2.8	M12	0.5	2.8mm	F2.0	139	116	71.2	129.0	102	75.3	94.8	75.3	56.2	×
2	T2820KF3P	1/2.8	M12	0.5	2.8mm	F2.0	139	116	71.2	129.0	102	75.3	94.8	75.3	56.2	○

## 1 MEGAPIXEL BOARD LENS

1/2" 1MP FIX BOARD

• Compatible with 1/2" sensor • Tough and compact design • M12, P0.5 mount



H0320KP



H0624KP

No.	Model Name	Format Inch	Mount	Pitch	Focal Length (mm)	Aperture (F)	Optical Distortion	Angle of view at Inf. (degrees)			Angle of view at Inf. (degrees)			Angle of view at Inf. (degrees)		
								1/2"			1/3"			1/4"		
								D	H	V	D	H	V	D	H	V
1	H0320KP	1/2	M12	0.5	3mm	F2.0	-37.5%	125.3	104.3	80.5	98.6	80.5	61.3	75.8	61.3	46.3
2	H0624KP	1/2	M12	0.5	6mm	F2.4	-9.0%	72.5	59.1	45.0	55.6	45.0	34.0	42.3	34.0	25.6
3	H0924KP	1/2	M12	0.5	9mm	F2.4	-1.6%	48.6	39.6	30.1	37.3	30.1	22.7	28.3	22.7	17.1
4	H1620KP	1/2	M12	0.5	16mm	F2.0	0.4%	27.9	22.6	17.0	21.2	17.0	12.8	16.0	12.8	9.6
5	H2520KP	1/2	M12	0.5	25mm	F2.0	1.0%	18.0	14.5	10.9	13.6	10.9	8.2	10.3	8.2	6.2

## 3 MEGAPIXEL ULTRA-LOW DISTORTION BOARD LENS

1/1.8" 3MP FIX BOARD

• Ultra-low distortion (optical distortion 0.1% or less) • Compatible with 1/1.8" sensor  
• M12, P0.5 mount • Tough and compact design



E1220KV



E2520KV

No.	Model Name	Format Inch	Mount	Pitch	Focal Length (mm)	Aperture (F)	Optical Distortion	Angle of view at Inf. (degrees)			Angle of view at Inf. (degrees)			Angle of view at Inf. (degrees)		
								1/1.8"			1/2"			1/3"		
								D	H	V	D	H	V	D	H	V
1	E1220KV	1/1.8	M12	0.5	12.0mm	F2.0	0.04%	39.5	32.1	24.4	36.8	29.8	22.6	28.1	22.6	17.1
2	E1620KV	1/1.8	M12	0.5	16.0mm	F2.0	-0.07%	30.0	24.3	18.4	27.9	22.6	17.0	21.2	17.0	12.8
3	E2520KV	1/1.8	M12	0.5	25.0mm	F2.0	0.02%	19.5	15.7	11.9	18.1	14.6	11.0	13.7	11.0	8.2



# MEGAPIXEL FISHEYE BOARD LENS



## 4K FISHEYE BOARD LENS

1/1.7" 4K IR FIX FISHEYE

- Compatible with 1/1.7" sensor • IR corrected • 12MP ultra-high resolution
- ImmerVision enables compatible (E1222KRY, E1222KF3RY)



No.	Model Name	Format Inch	Mount	Pitch	Focal Length (mm)	Aperture (F)	Angle of view at Inf. (degrees)			Angle of view at Inf. (degrees)			Angle of view at Inf. (degrees)			IRCF
							1/1.7"			1/3"			1/4"			
							D	H	V	D	H	V	D	H	V	
1	E1628KRY	1/1.7	M12	0.5	1.6mm	F2.8	190.0	190.0	168.2	125.5	157.3	125.5	94.2	×		
2	E1222KRY	1/1.7	M12	0.5	1.2mm	F2.2	185.0	185.0	171.5	139.5	164.2	139.5	110.3	×		
3	E1628KF3RY*	1/1.7	M12	0.5	1.6mm	F2.8	190.0	190.0	168.2	125.5	157.3	125.5	94.2	○		
4	E1222KF3RY*	1/1.7	M12	0.5	1.2mm	F2.2	185.0	185.0	171.5	139.5	164.2	139.5	110.3	○		
5	E2328KRY	1/1.8	M12	0.5	2.3mm	F2.8	1/1.8"			1/2"			1/3"			×
							-	190.0	108.6	-	159.0	119.5	149.2	119.5	89.6	

\*Please note E1628KF3RY and E1222KF3RY are produced to order.

## 5 MEGAPIXEL FISHEYE BOARD LENS

1/2.5" 5MP IR FIX FISHEYE

- Compatible with 1/2.5" sensor • IR corrected • 5MP ultra-high resolution • IP66 (L1028KDRW)
- ImmerVision enables compatible



No.	Model Name	Format Inch	Mount	Pitch	Focal Length (mm)	Aperture (F)	Angle of view at Inf. (degrees)			Angle of view at Inf. (degrees)			Angle of view at Inf. (degrees)			Water Proof
							1/2.5"			1/3"			1/4"			
							D	H	V	D	H	V	D	H	V	
1	L1028KRW	1/2.5	M12	0.5	1.05mm	F2.8	180.0	180.0	163.2	180.0	163.2	130.2				
2	L1028KDRW	1/2.5	M12	0.5	1.05mm	F2.8	180.0	180.0	163.2	180.0	163.2	130.2	○			

## 3 MEGAPIXEL FISHEYE BOARD LENS

1/3" 3MP IR FIX FISHEYE

- Compatible with 1/3" sensor • IR corrected • 3MP ultra-high resolution • ImmerVision enables compatible



No.	Model Name	Format Inch	Mount	Pitch	Focal Length (mm)	Aperture (F)	Angle of view at Inf. (degrees)			Angle of view at Inf. (degrees)			Angle of view at Inf. (degrees)		
							1/2"			1/3"			1/4"		
							D	H	V	D	H	V	D	H	V
1	T0928KRW	1/3	M12	0.5	0.95mm	F2.8	-	-	-	180.0	180.0	180.0	145.2		



## 1. Calculation of Working Distance (WD)

Distance from lens to object (WD) is calculated by putting the size of a camera's imaging device, focal length and an object size into the following formula.

<Formula>  
 $WD = H1 + y \times f / y'$

[ Ex ]  
 When 2/3" camera with M2514-MP films an object whose vertical size is 120 mm.  
 f : 25 mm  
 H1 : 26.77mm  
 y : 120mm  
 y' : 6.6mm

Distance from lens to object=  
 $WD = 26.77 + 120 \times 25 / 6.6 = 481.32 \text{ mm}$

## 2. Calculation of Focal Length

When choosing size of a camera's imaging device, the object size and WD are fixed, focal length can be calculated by the following formula. You can select appropriate lens from the focal length.

<Formula>  
 $f = y' \times WD / y$

f = focal length of lens  
 WD = distance from lens to object  
 H1 : first principal point  
 y : vertical size of object  
 y' : vertical size of camera's imaging device

## CAMERA FORMAT

The size of camera's imaging device also affects the angle of view, with the smaller devices creating narrower angles of view when used on the same lens. The format of the lens, however is irrelevant to the angle of view, it merely needs to project an image which will cover the device, i.e.; the same format of the camera or larger. This also means that 1/3" cameras can utilize the entire range of lenses from 1/3" to 2/3", with a 1/3" 8mm lens giving the same angle as a 2/3" 8mm lens. The latter combination also provides increased resolution and picture quality as only the centre of the lens is being utilized, where the optics can be ground more accurately.

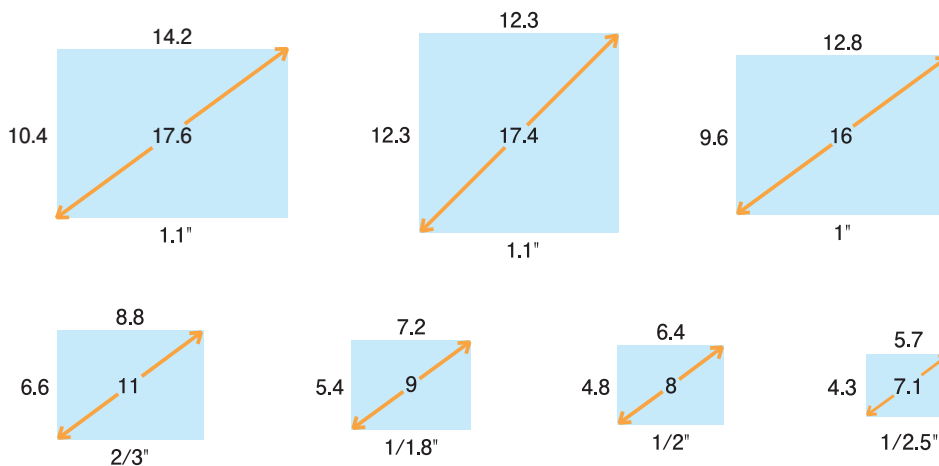
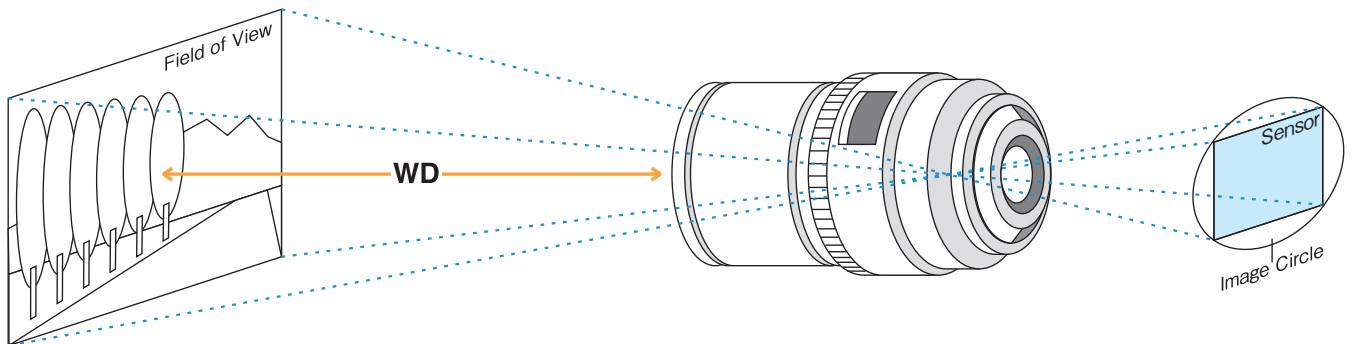





## C OR CS MOUNT

Modern cameras and lenses are generally CS mount, with CS mount cameras both types of lenses can be used but the C mount lens requires a 5mm ring (VM400) to be fitted between the camera and lens to achieve a focused image. With C mount cameras it is not possible to use CS mount lenses as it not physically possible to get the lens close enough to the sensor to achieve a focused image.

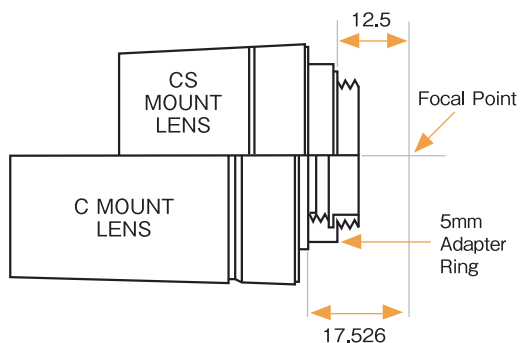

	C mount lens	CS mount lens
C mount camera	○	×
CS mount camera	needs 5mm ring	○

## FLANGE BACK, BACK FOCAL LENGTH, AND MECHANICAL BACK FOCAL LENGTH

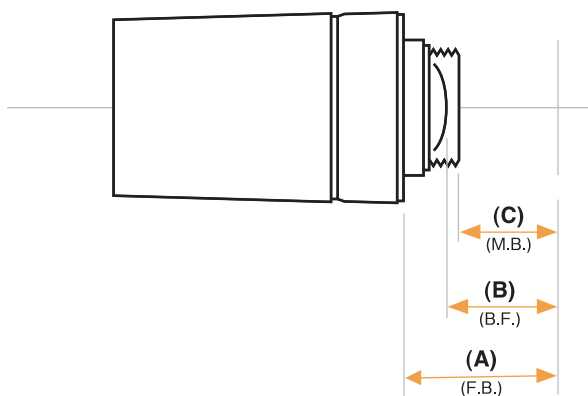

### (A) Flange Back

Distance between the lens flange and CCD focal plane

### (B) Back Focal Length

Distance between the surface of the rear lens element and CCD focal plane

### (C) Mechanical Back Focal Length

Distance between the surface of the lens frame and CCD focal plane

## ASPHERICAL LENSES

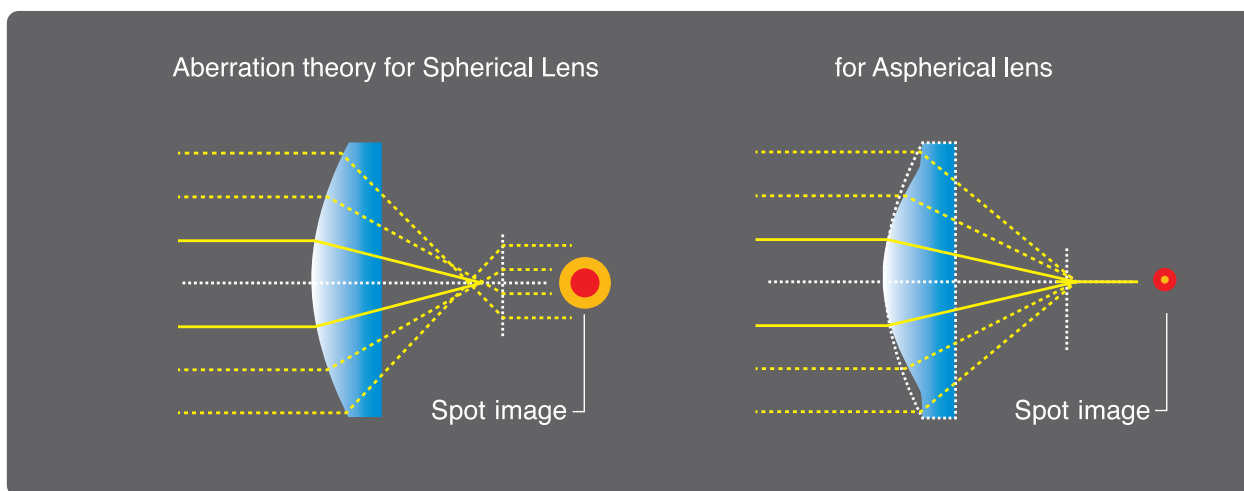

Spherical lenses have constant refractive indices and are commonly used in almost all CCTV lenses. They are designed in such a way so that light passing through the glass and center of a spherical element should fall on a single point on the image plane, but causing some spherical aberration. This problem is resolved by the aspherical lens technology, enabling more light to pass through the element and to focus right on the same point as on the image plane. Supported by more advanced molding technologies, aspherical lenses eliminate the size constraints and improve the overall optical performance compared with more conventional CCTV lenses.



**MECHANISM AND ADVANTAGEOUS EFFECT OF IR LENS**

■ **NON IR LENS**

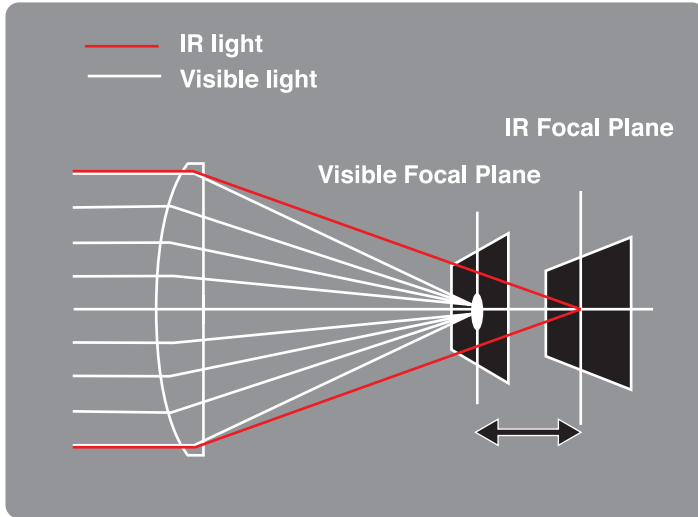

■ **IR LENS**

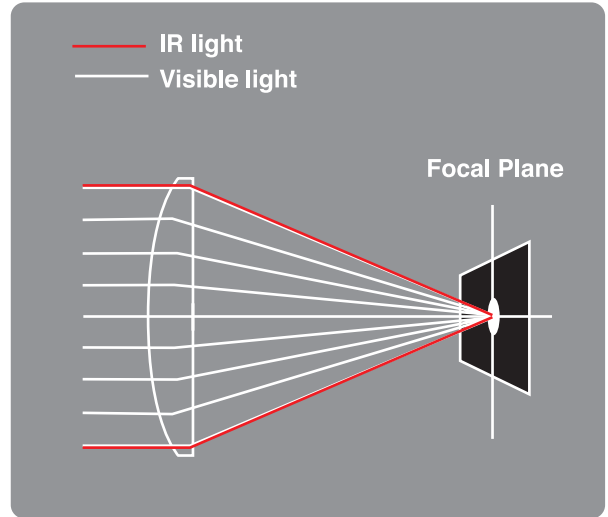

Day & Night cameras normally operate in the near-infrared / infrared zones at night, making the image "out of focus" and unsuitable if used with a conventional lens. Computar® has developed IR Lenses that utilize a special optical glass material which minimizes light dispersion. As a result, refocusing is not required when used with infrared lighting. The lens is manufactured with a special ED glass (extra dispersion) which does not widely disperse light of different wavelengths and with "special coating". This combination allows the lens to deliver perfect focus under normal lighting and also under IR illumination by transmitting more light to the infrared region.

**Daytime**



**Nighttime**

**IR lens**

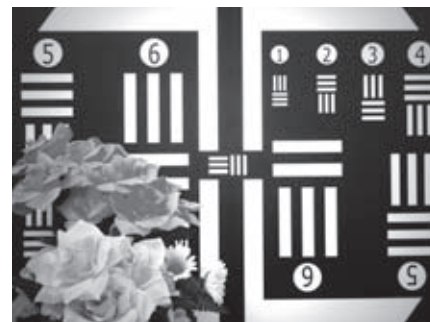

**Non IR lens**



※ Monitoring images with Day & Night cameras

# CBC WORLDWIDE NETWORK

## America

### **CBC AMERICA LLC North Carolina**

2000 Regency parkway, Suite 600  
Cary, NC, 27518, U.S.A.  
TEL : +1 919 230 8700  
FAX : +1 919 230 2268  
<http://www.computar.com>  
[computar@cbcamerica.com](mailto:computar@cbcamerica.com)

### **CBC AMERICA LLC Los Angeles Division**

21241 South Western Avenue, Suite #160  
Torrance, CA 90501, U.S.A.  
Tel : +1 877 407 9555  
Fax : +1 310 787 0464  
<http://www.computar.com>  
[computar@cbcamerica.com](mailto:computar@cbcamerica.com)

## Europe

### **CBC (EUROPE) GmbH Düsseldorf**

Hansaallee 191  
D-40549 Düsseldorf, GERMANY  
Tel : +49 (0)211 53067 0  
Fax : +49 (0)211 53067 180  
<http://www.cbc-europe.com>  
[info@cbc-europe.com](mailto:info@cbc-europe.com)

### **CBC (EUROPE) GmbH UK Branch London**

Churchill House Suit 81  
137-139 Brent Street, London NW4 4DJ, UK  
Tel : +44(0)20 8457 2620  
[www.cbc-europe.com](http://www.cbc-europe.com)  
[uksalesorders@cbcuk.com](mailto:uksalesorders@cbcuk.com)

### **CBC (Europe) S.r.l. Milan**

Via Umberto I, 69  
20814 Varedo (MB) - ITALY  
Tel : +39 0362 365079  
Fax : +39 0362 40012  
<http://www.computar.it>  
<http://computarganz.it>  
[sales@cbceurope.it](mailto:sales@cbceurope.it)

### **CBC (Poland) Sp.z o.o. Warszawa**

Ul. Anny German 15  
01-794 Warszawa  
Tel : +48 22 633 90 90  
<http://www.cbcpoland.pl>  
[info@cbcpoland.pl](mailto:info@cbcpoland.pl)

### **CBC Co., Ltd. MOSCOW REP OFFICE Moscow**

Office 503B, Entrance#3, Building 1,  
World Trade Center, 12 Krasnopresnenskaya nab.,  
Moscow, 123610, RUSSIA  
Tel : +7 495 258 2161  
Fax : +7 495 258 2160  
<http://www.cbc.ru>  
[support@cbc.ru](mailto:support@cbc.ru)

## China

### **CBC(Beijing)Trading CO.,LTD Beijing**

Room B16E No.18 Xia Guang Li Gateway Plaza,  
North Road East Third Ring, Chaoyang District,  
Beijing,10027, China  
Tel : +86 10 6410 8081  
Fax : +86 10 6410 8085  
<http://www.cbc-china.cn/>

### **CBC (SHANGHAI) Trading CO., Ltd. Shanghai**

Room 1801, GIFC, No.1438 HongQiao Road,  
Changning District, Shanghai, CHINA  
Tel : +86 21 3209 2626  
Fax : +86 21 3209 2814  
<http://www.cbc-china.cn/>  
[support@cbcsh.com.cn](mailto:support@cbcsh.com.cn)

### **CBC (GUANGZHOU) Trading CO., Ltd. Guangzhou**

Room 1207, CITIC Praza, No.233 Tian He North  
Road, Guangzhou City, Guangdong Province,  
CHINA  
Tel : +86 20 8752 0039  
Fax : +86 20 8752 0131  
<http://www.cbc-china.cn/>

### **CBC (H.K.) CO., LTD. Hong Kong**

Unit 901, 9/F, Tower5,  
China Hong Kong City, 33 Canton Road,  
Tsim Sha Tsui, Kowloon, Hong Kong, CHINA  
Tel : +852 2345 8686  
Fax : +852 2887 2457  
<http://www.cbc-china.cn/>

## Asia

### **T-CBC (TAIWAN) CO., Ltd. Taiwan**

Room D, 10th Floor, No.365 Fushing N. Rd.,  
Taipei, 10543, TAIWAN, R. O. C.  
Tel : +886 2 6600 8001  
Fax : +886 2 6600 5211  
<http://www.t-cbc.com.tw/>  
[cbc@t-cbc.com.tw](mailto:cbc@t-cbc.com.tw)

### **CBC (Thailand) Co.,Ltd. Bangkok**

23rd Floor, ITF Tower 2, 140/53-55  
Silom Road, Suriyawongse,  
Bangrak, Bangkok 10500  
THAILAND  
Tel : +66 2231 6181  
Fax : +66 2231 6180  
<http://www.cbcthailand.com/>

### **CBC Corporation (India) Private Limited Mumbai**

2F B Wing, Marwah Centre,  
Krishanlal Marwah Marg,  
Andheri East, Mumbai 400 072, INDIA  
Tel : +91 22 2857 9798  
Fax : +91 22 6649 1708  
[enquiry@cbcindia.jp](mailto:enquiry@cbcindia.jp)

# computar®



**Head Quarters**

Business Development & Manufacturing Division  
2-15-13, Tsukishima, Chuo-ku,  
Tokyo 104-0052, Japan  
TEL:+81(0)3 3536 4766 FAX:+81(0)3 3536 4172  
[www.cbc.co.jp](http://www.cbc.co.jp)

[www.computar-global.com/jp/](http://www.computar-global.com/jp/)  
[www.computar-global.com](http://www.computar-global.com)

Tokyo HQ Registered



Tokyo HQ Registered



2020.07