

Mini PTZ CAMERA

ZC-PT SERIES (Indoor)

USER' S MANUAL

GAMZ®



Preface

The information given in this manual was current when published. The company reserves the right to revise and improve its products. All specifications are subject to change without notice.

Notice

To work with the Mini PTZ Cameras, any installer or technician must have the following minimum qualifications:

- A basic knowledge of CCTV systems and components
- A basic knowledge of electrical wiring and low-voltage electrical hookups
- A basic knowledge of network system setting
- Have read this manual completely

Copyright

Under copyright laws, the contents of this user manual may not be copied, photocopied, translated, reproduced or reduced to any electronic medium or machine-readable format, in whole or in part, without prior written permission of the company.

Important Information

Before proceeding, please read and observe all instructions and warnings in this manual. Retain this manual with the original bill of sale for future reference and, if necessary, warranty service. When unpacking your unit, check for missing or damaged items. If any item is missing, or if damage is evident, DO NOT INSTALL OR OPERATE THIS PRODUCT. Contact your dealer for assistance.

Regulation

	This device complies with Part 15 of the FCC Rules. Operation is subject to the following two conditions: (1) this device may not cause harmful interference, and (2) this device must accept any interference received, including interference that may cause undesired operation.
---	---

	<p>This symbol on the product or on its packaging indicates that this product shall not be treated as household waste in accordance with Directive 2002/96/EC. Instead it shall be handed over to the applicable collection point for the recycling of electrical and electronic equipment. By proper waste handling of this product you ensure that it has no negative consequences for the environment and human health, which could otherwise be caused if this product is thrown into the garbage bin. The recycling of materials will help to conserve natural resources.</p> <p>For more details information about recycling of this product, please contact your local city office, your household waste disposal service or the shop where you purchased the product.</p>
---	---

	<p>Compliance is evidenced by written declaration from our suppliers, assuring that any potential trace contamination levels of restricted substances are below the maximum level set by EU Directive 2002/95/EC, or are exempted due to their application.</p>
---	---

Cautions

- **Handle the camera carefully**
Do not abuse the camera. Avoid striking, shaking, etc. The camera could be damaged by improper handling or storage.
- **Installing electricity wiring carefully**
Ask qualified personnel of electrical wiring for the installation. Please note that input electricity to the unit is at tolerance of DC 12V/AC 24V \pm 10%.

The camera is capable of surge protection; ensure AC power model unit grounded appropriately against damage of heavy current or electric shock.
- **Do not disassemble the camera**
To prevent electric shock, do not remove screws or covers. There are no user serviceable parts inside. Ask a qualified service person for servicing.
- **Do not block cooling holes on the bracket**
This camera has a cooling fan inside. Blocking the cooling holes leads to build up heat of the camera and may cause malfunction.
- **Do not operate the camera beyond the specified temperature, humidity or power source ratings**
Use the indoor PTZ Camera under conditions where temperature is between 0°C ~ 40°C (32°F ~ 104°F) and the outdoor camera under conditions where temperature is between -30°C~45°C (-22°F~113°F), and humidity is below 90%.
- **Do not expose the indoor PTZ Camera to rain or moisture, or try to operate it in wet areas**
The indoor PTZ Camera is designed for indoor use or locations where it is protected from rain and moisture. Turn the power off immediately if the camera is wet and ask a qualified service person for servicing. Moisture can damage the camera and also create the danger of electric shock.
- **Do not use strong or abrasive detergents when cleaning the camera body**
Use a dry cloth to clean the camera when it is dirty. In case the dirt is hard to be removed, use a mild detergent and wipe gently.

- **Never face the camera towards the sun**

Do not aim the camera at bright objects. Whether the camera is in use or not, never aim it at the sun or other extremely bright objects. Otherwise, the camera may be smeared or damaged.

Table of Contents

1. Overview	7
1.1 Product Features	8
1.2 Product Application	9
2. Connecting the Mini PTZ Camera	10
2.1 Package Content	10
2.2 Switch/Connector Definition	11
2.3 Communication Switch Setting	12
2.4 ID Setup	13
2.5 Camera Control Protocol Setup	14
2.6 22-Pin Connector Definition	15
2.7 RS-485 Connector Definition	16
3. Operation and Configuration	17
3.1 OSD Display Format	17
3.2 OSD Menu Tree	18
3.3 Configuration Menu	22
3.3.1 LANGUAGE	22
3.3.2 DEFAULT CAMERA	23
3.3.3 BACKLIGHT	23
3.3.4 FOCUS	23
3.3.5 AE MODE	24
3.3.6 WBC MODE	25
3.3.7 SETUP MENU 1	26
• DIGITAL ZOOM	26
• SLOW SHUTTER	26
• DIGITAL NOISE REDUCTION (D.N.R.)	27
• IMAGE INVERSE	27
• FREEZE	27
• APERTURE	27
• EXIT	28
3.3.8 SETUP MENU 2	28
• FLIP	28
• ANGLE ADJUSTER	29
• SPEED BY ZOOM	29
• AUTO CALI. (Auto Calibration)	29
• PASSWORD	29
• OSD AUTO CLOSE	30
• SYSTEM RESET	30
• EXIT	31
3.3.9 ID DISPLAY	31
3.3.10 TITLE DISPLAY	31
3.3.11 TITLE SETTING	32

3.3.12	PRESET	33
3.3.13	SEQUENCE	34
3.3.14	AUTOPAN	35
3.3.15	CRUISE	37
3.3.16	HOME SETTING	39
3.3.17	IR FUNCTION	41
3.3.18	ALARM SETTING	42
3.3.19	ALARM DETECT	45
3.3.20	WDR FUNCTION	47
3.3.21	PRIVACY MASK	48
3.3.22	TIME SETTING	50
3.3.23	SCHEDULE FUNCTION	51
3.3.24	EXIT OSD	52
Appendix A: Technical Specification		53
Appendix B: Switch Settings Index Table.....		55
	Camera ID Setup	55
	Protocol Setup	62
Appendix C: OSD Menu Notes.....		63

1. Overview

The Mini PTZ Camera is an innovative PTZ Camera designed for middle and small surveillance applications and possesses true PTZ Camera features, such as high speed and accurate Pan/Tilt, up to 12×12 zoom ratio, 180° Digital Image Flip, Speed by Zoom, and Preset Speed up to 400°/s. Additionally, it contains 256 Preset Points, 8 Sequence Lines, 4 Auto Pan Lines and 8 Cruise Lines to support automatic operations. It is ideal for all surveillance requirements in hotels, department stores, intelligent buildings, amusement parks, parking lots, factories, hospitals, schools, stations etc.

The Mini PTZ Camera contains various solutions for low light and high contrast conditions. For example, a bright background or shade can result in the subject of the image appearing darker. The backlight compensation function gives a bright and beautiful image.

The Mini PTZ Camera supports one cabling for easy installation, and can be integrated with various digital surveillance products, such as DVRs, Control Keyboards and various sorts of accessories for a total surveillance solution. The camera is incorporated with multiple protocols: DynaColor, Pelco, VCL, Philips, etc. to enhance powerful connectivity.

1.1 Product Features

Precise and Accurate Mini PTZ Camera Performance

- High Resolution 540 TV lines
- Preset Speed up to 400°/sec
- Preset Accuracy of 0.225°
- 360° Endless Pan
- Proportional Pan & Tilt Speed
- Preset Positions / Auto-Pan / Sequence / Cruise
- Auto-Calibration
- Digital / Mechanical Image Flip (180°)

Dynamic PTZ Camera Applications

- Schedule function
- Multiple built-in protocols
- Extraordinary lightweight design for easy installation
- Vandal proof dome cover (Optional)
- Flexible indoor mountings
- 16 Privacy Masks
- Motion Detection

Superior Camera Image Quality

- 12× Optical Zoom
- 12× Digital Zoom
- Digital Slow Shutter
- Backlight Compensation
- Auto Focus
- Auto White Balance
- Auto Gain Control
- Auto Iris Control
- Auto-Calibration
- Removable IR Cut Filter
- Minimum Illumination: 0.1 Lux, 0.01 Lux (B/W)
- Wide Dynamic Range
- 2D / 3D Noise Reduction

1.2 Product Application

Connect PTZ Cameras to other devices, as shown in the diagram, to complete a video surveillance solution.

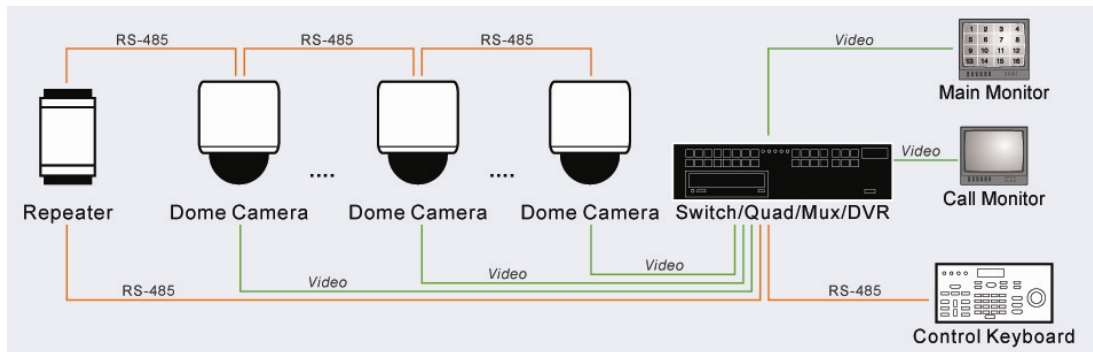

NOTE: To extend the network distance up to 1.2 km (4000 feet) and to protect the connected devices, it is highly recommended to place a repeater at the mid-point. However, a repeater may be needed in the network distance less than 1.2 km if the used cables are not the CAT 5, 24-gauge cables; see [2.7 RS-485 Connector Definition \(Analog\)](#). Refer to the repeater's manual for detailed information.



2. Connecting the Mini PTZ Camera

Please refer to the following sections to connect, set and operate the PTZ Camera. In order to control the camera, basically a control keyboard or other control device is required.

2.1 Package Content

Before proceeding, please check the box contains the items listed here. If any item is missing or has defects, DO NOT install or operate the product and contact your dealer for assistance.

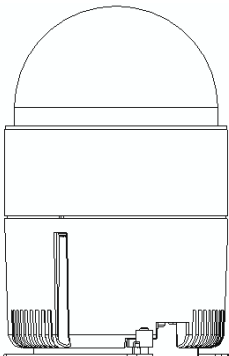
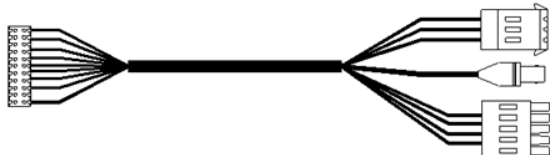
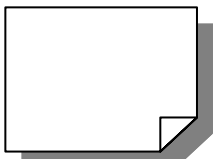
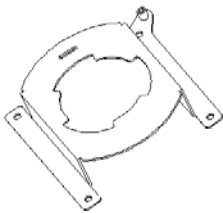
Mini Indoor PTZ Camera Package

 <p>PTZ Camera</p>	 <p>Data Cable for Power Supply, Video and RS-485 (for AC 24V model)</p>	
 <p>Quick Guide</p>	 <p>Hard Ceiling Mount</p>	 <p>M3 Screw, Fixing Plate</p>
 <p>CD: Operation Manuals</p>		

2.2 Switch/Connector Definition

Configuring the PTZ Camera's ID and communication protocol are required before connecting the analog camera to other devices. The switches used for configuring these settings are located on the bottom of the PTZ Camera. Additionally, the 22-Pin Connector for Data Cable connection and ISP Connector for firmware upgrade kit connection are located on the back plate of the PTZ Camera. Please refer to the diagrams and tables accompanied with for use of each switch/connector.

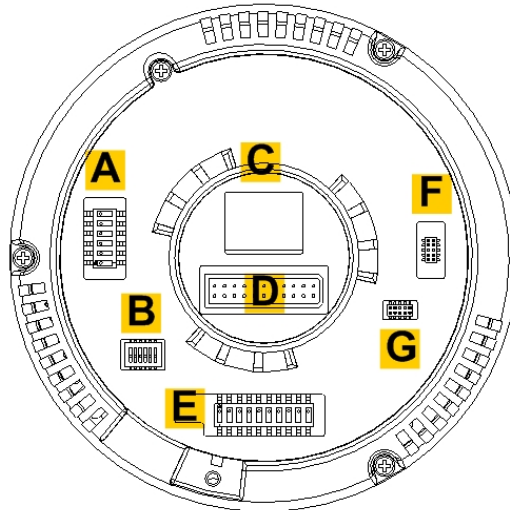

A	Camera Control Protocol Switch
B	Communication Switch
C	None
D	22-Pin Connector
E	ID Switch
F	Reserved
G	ISP Connector (for FW upgrade)



The ID and Protocol numbers of an analog camera are set with a 10-bit and 6-bit dip switch respectively using binary system. For switch configuration details, please refer to [Appendix B: Switch Settings Index Table](#).

2.3 Communication Switch Setting

The PTZ Camera's communication switches are specified in the table below.

Communication Switch	SW 1		
	SW 2		RS-485 Setting
	SW 3		Termination
	SW 4		Line Lock
	SW 5		Factory Default Reset
	SW 6		Camera Upgrade

RS-485 is the interface that communicates the PTZ Camera and its control device; for this reason, the RS-485 setup of the PTZ Camera and the control device must be the same. The RS-485 default setting is half-duplex (see the diagram follows). Please do not change the default setting without qualified specialist or supplier's notice. As for the SW 3 and SW 4, they are used for termination and Line Lock adjustment respectively. The SW 5 is mainly used when users want to restore the camera to the factory default status; moreover, once firmware upgrade is carried out, users need to reset the SW 6 afterward.

RS-485 Setting	
Half-duplex 	Full-duplex 

2.4 ID Setup

Please change the PTZ Camera's ID if there is more than one PTZ Camera in the same network. Use the switch to change your PTZ Camera's ID by setting the 10-bit dip switch. For instance, if the camera's ID is 006, set the SW-2 and SW-3 to "ON," with the rest to "OFF," as shown below.

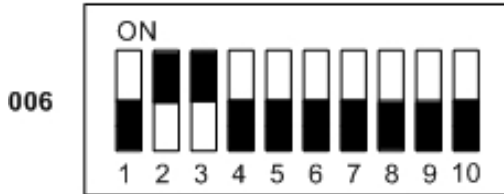

For switch configuration details, please refer to [Appendix B: Switch Settings Index Table](#).



NOTE: No two PTZ Cameras should be given the same ID, or communication conflict may occur.

2.5 Camera Control Protocol Setup

Define the protocol you are going to use basing on the devices of your surveillance system. Generally, use one protocol even the devices are provided from different manufacturers. Please refer to the table below for all supported protocols with their matching switch numbers and baud rate and choose a protocol for your PTZ Camera.

Switch No.	Protocol	Baud Rate
00	VCL	9600
01	Pelco D	2400
02	Pelco P	4800
04	Chiper	9600
05	Philips	9600
07	DSCP	9600
08	AD422	4800
09	DM P	9600
11	Pelco D	4800
12	Pelco D	9600
13	Pelco P	2400
14	Pelco P	9600
15	JVC	9600
21	Kalatel-485	9600
22	Kalatel-422	4800
23	Panasonic	19200

Use the 6-bit dip switch (Camera Control Protocol Switch) to set your camera's control protocol and its baud rate.

If select protocol: Pelco D, which is of switch no. 01 and baud rate 2400, for instance, set the SW-1 to "ON," with the rest to "OFF," as shown below.



For switch configuration details, please refer to [Appendix B: Switch Settings Index Table](#).

2.6 22-Pin Connector Definition

A Data Cable is shipped with the PTZ Camera for a quick installation for demo or testing usage. Additionally, the PTZ Camera's 22-pin connector definition will also be specified later. For more information about RS-485 connector, see [2.7 RS-485 Connector Definition](#).

The PTZ Camera's Data Cable is illustrated as shown below.

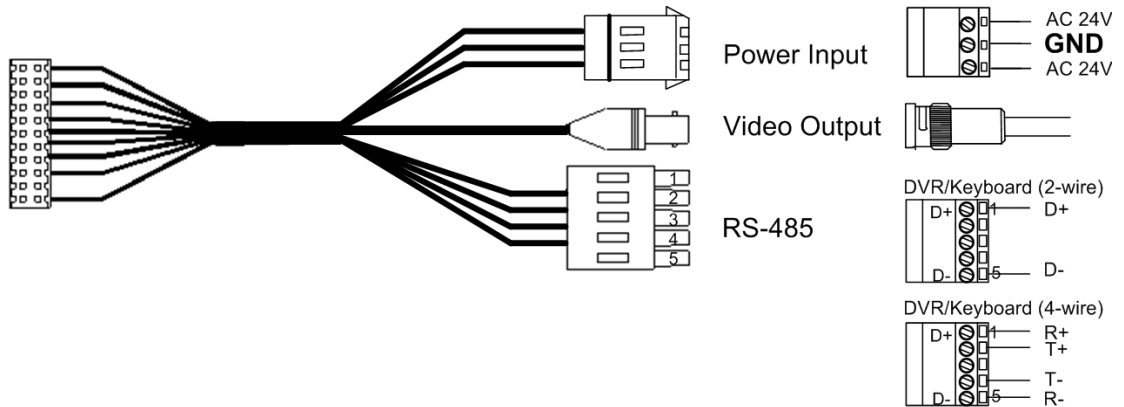

NOTE: Be careful not to pull the cables improperly during installation. Additionally, it is suggested to fasten the cables after cable connection is completed. Furthermore, when wiring the AC 24V power cable, make sure the **Ground** wire inserted into the mid-pin of the terminal block.

The PTZ Camera's 22-pin connector definition is listed as shown below.

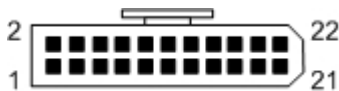

Pin	Definition	Cable
1	AC 24-1/DC (+)	20AWG/18AWG
2	ALM NC	
3	AC 24-2/DC (-)	20AWG/18AWG
4	ALM NO	
5	FG	20AWG/18AWG
6	ALM COM	
7	T+	24AWG
8	R-	
9	T-	
10	R+	
11	ISOG	

Pin	Definition	Cable
12	ALM-1	
13	ALM-3	
14	ALM-2	
15	ALM-4	
16	ALM-5	
17	ALM-6	
18	ALM-7	
19	ALM-8	
20	ALM GND	
21	VGND	20AWG
22	Video	

2.7 RS-485 Connector Definition

RS-485 is the interface that communicates the analog PTZ Camera and its control device. Please connect the control keyboard to the PTZ Camera through the terminal block. The recommended cables for RS-485 communication are **CAT 5** cables; maximum cable length for over 24-gauge wire is 4000 feet (1219 meters). If the total cable length exceeds 4000 feet, using a repeater to maintain the signals is recommended. Please refer to the figure and table below for pin definition and wiring.

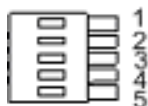

Pin	Corresponding Pins (22-Pin Connector)	Definition
1	7,10	T+, R+ (D+)
2~4	Reserved	
5	8,9	T-, R- (D-)

3. Operation and Configuration

3.1 OSD Display Format

Information shown on the screen are described in terms of OSD display, position and function description; see the table below.

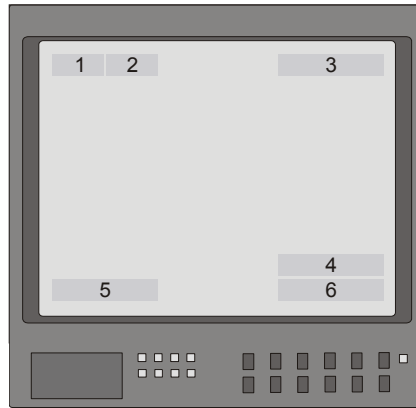

Position	Function	OSD Display	Description
1	Focus Modes	A	Auto Focus Mode
		M	Manual Focus Mode
2	Backlight	X	Back Light Compensation OFF
		B	Back Light Compensation ON
3	Alarm	ALARM	Alarm Message
4	Zoom Ratio	×1	Present Zoom Ratio (Optical Zoom/Digital Zoom)
5	Title	<ul style="list-style-type: none"> • Maximum 20 characters for each title. • 16 sets of title are available. 	
6	Camera ID	Show the camera ID	

3.2 OSD Menu Tree

The OSD setup menu structure is listed in the following section. The star symbol indicates the factory default. For detailed function description, please see section [3.3 Configuration Menu](#).

Mini PTZ Camera Menu Tree

Item	Layer 1	Layer 2	Layer 3	Default	
LANGUAGE	<ENGLISH>, <PORTUGUESE>, <SPANISH>, <FRENCH>, <GERMAN>, <ITALIAN>			ENGLISH	
DEFAULT CAMERA	<ON>, <OFF>			ON	
BACKLIGHT	<ON>, <OFF>			OFF	
FOCUS	<AUTO>	AF MODE <NORMAL>, <Z. TRIG.>, <PTZ TRIG.> EXIT + SAVE: YES		AUTO	
	<MANUAL>				
AE MODE	EXPOSURE COMP.	<OFF>, EXPOSURE VALUE: <-10.5dB> ~ <10.5dB> EXIT + SAVE: YES			
		AE MODE	AUTO	BRIGHT VALUE; SHUTTER SPEED; IRIS VALUE; GAIN VALUE: AUTO EXIT + SAVE: YES	
	SHUTTER		SHUTTER SPEED PAL:<1/50>~ <1/10000> SEC. NTSC: <1/60>~ <1/10000> SEC. EXIT + SAVE: YES		
	IRIS		IRIS VALUE <F1.6> EXIT + SAVE: YES		
	MANUAL		BRIGHT VALUE: AUTO SHUTTER SPEED PAL:<1/50> ~ <1/10000> SEC. NTSC: <1/60> ~ <1/10000> SEC. IRIS VALUE <F1.6> GAIN VALUE <-3>dB ~ <28>dB EXIT + SAVE: YES		
	EXIT+ SAVE:	YES			
	WBC MODE	AUTO (Auto White Balance)			☆
		INDOOR			
		OUTDOOR			
		ATW (Auto-tracing WBC)			
MANUAL		R GAIN <000> ~ <127> B GAIN <000> ~ <127> EXIT + SAVE: YES			
SETUP MENU 1	ENTER	ZOOM SPEED	<8>	8	
		DIGITAL ZOOM	<ON>, <OFF>	OFF	
		SLOW SHUTTER	<ON>, <OFF>	OFF	
		D.N.R.	2D N.R. <ON>, <OFF>	ON	
			3D N.R. <ON>, <OFF> EXIT + SAVE: YES	ON	
		IMAGE INVERSE	<ON>, <OFF>	OFF	
		FREEZE	<ON>, <OFF>	OFF	
		APERTURE	<01> ~ <16>	07	

Item	Layer 1	Layer 2	Layer 3	Default
SETUP MENU 2	ENTER	EXIT	<YES>	
		FLIP	<OFF>, <M.E.>, <IMAGE> EXIT + SET: YES	OFF
		ANGLE ADJUSTER	ADJUST MIN ANGL <-10> ~ <+10> DEG	00
			ADJUST MAX ANGL <080> ~ <100> DEG	90
			EXIT + SET: YES	
		SPEED BY ZOOM	<ON>, <OFF>	OFF
		AUTO CALI.	<ON>, <OFF>	OFF
		PASSWORD	<ON>, <OFF>	OFF
		OSD AUTO CLOSE	<OFF>, <5> ~ <30> SEC.	20
		SYSTEM RESET	SYSTEM RESET <YES>	
			DEFAULT SYSTEM <YES>	
EXIT <YES>				
EXIT	<YES>			
ID DISPLAY	<ON>, <OFF>		ON	
TITLE DISPLAY	<ON>, <OFF>		OFF	
TITLE SETTING	<01> ~ <16>		01	
PRESET	PRESET SET	<001>~<256>	ENTER	
	PRESET RUN	<001>~<256>	ENTER	
	EXIT	YES	ENTER	
SEQUENCE	ENTER	SEQUENCE LINE	<1> ~ <8>	1
		SEQUENCE POINT	<01> ~ <64>	01
		PRESET POS.	<001> ~ <255>, <END>	001
		SPEED	<01> ~ <15>	01
		DWELL TIME	<000> ~ <127> SEC.	000
		RUN SEQUENCE	ENTER	
		EXIT	<YES>	
AUTOPAN	ENTER	AUTOPAN LINE	<1> ~ <4>	1
		START POINT	<TO FIND>, <TO SAVE>	
		END POINT	<TO FIND>, <TO SAVE>	
		DIRECTION	<RIGHT>, <LEFT>	Right
		SPEED	<01> ~ <04>	01
		RUN AUTOPAN		
		EXIT		
CRUISE	ENTER	CRUISE LINE	<1> ~ <8>	1
		RECORD START	ENTER	
		RECORD END	ENTER	
		RUN CRUISE	ENTER	
		EXIT	ENTER	
HOME SETTING	ENTER	HOME FUNCTION	<ON>, <OFF>	OFF
		SELECT MODE	PRESET	☆
			SEQUENCE	
			AUTOPAN	
			CRUISE	
		PRESET POINT SEQUENCE LINE AUTOPAN LINE CRUISE LINE	<001> ~ <256> <001> ~ <008> <001> ~ <004> <001> ~ <008>	001
		RETURN TIME	<001> ~ <128> MIN.	001
		GO	ENTER	
EXIT	YES			
IR FUNCTION	AUTO	THRESHOLD <MID>, <HI>, <LOW>		AUTO
		EXIT + SAVE: YES		
	MANUAL	IR MANUAL: <ON>, <OFF>		

Item	Layer 1	Layer 2	Layer 3	Default	
ALARM SETTING	ENTER	EXIT + SAVE: YES			
		ALARM PIN	<1> ~ <8>	1	
		ALARM SWITCH	<ON>, <OFF>	OFF	
		ALARM TYPE	<NO>, <NC>	NC	
		ALARM ACTION	PRESET		☆
			SEQUENCE		
			AUTOPAN		
			CRUISE		
PRESET POINT SEQUENCE LINE AUTOPAN LINE CRUISE LINE	<001> ~ <256> <001> ~ <008> <001> ~ <004> <001> ~ <008>		001		
DWELL TIME	<001> ~ <127> SEC., <ALWAYS>		ALWAYS		
EXIT	YES				
ALARM DETECT	DETECT SWITCH	<ON>, <OFF>		OFF	
	DETECT MODE	<MOTION>		MOTION	
	BLOCK MODE	<NONE>, <ON>, <OFF>		NONE	
	FRAME SET	NONE; MOTION: <01> ~ <04>		NONE	
	FRAME DISABLE	NONE; MOTION: <01> ~ <04>		NONE	
	THRESHOLD	NONE; MOTION: <001> ~ <255>		NONE	
	EXIT	YES			
WDR FUNCTION	<ON>, <OFF>				
PRIVACY MASK	PRIVACY SWITCH	<ON>, <OFF>			
	TRANSPARENCY	<ON>, <OFF>			
	COLOR	<BLACK>, <WHITE>, <RED>, <GREEN>, <BLUE>, <CYAN>, <YELLOW>, <MAGENT A>			
	SET MASK	<01> ~ <16>	H CENTER: L/R		
			V CENTER: D/U		
			H SIZE <000> ~ <080>	000	
			V SIZE <000> ~ <060>	000	
EXIT + SAVE					
CLEAR MASK	<01> ~ <16>				
EXIT	YES				
TIME SETTING	ENTER	TIME DISPLAY	<ON>, <OFF>	OFF	
		SET YEAR	<00> ~ <99>		
		SET MONTH	<01> ~ <12>		
		SET DAY	<01> ~ <31>		
		SET HOUR	<00> ~ <23>		
		SET MINUTE	<00> ~ <59>		
		EXIT+SAVE	YES		
SCHEDULE	SCHEDULE SWITCH	<ON>, <OFF>	OFF		
	POINT	<01> ~ <32>	01		
	HOUR	<00> ~ <23>	00		
	MINUTE	<00> ~ <59>	00		
	MODE	NONE		NO FUNCTION	☆
		PRESET		PRESET POINT <001> ~ <256>	
		SEQUENCE		SEQUENCE LINE <001> ~ <008>	
		AUTOPAN		AUTOPAN LINE <001> ~ <004>	
		CRUISE		CRUISE LINE <001> ~ <008>	
		IR FUNC.		IR FUNCTION <AUTO>, <ON>, <OFF>	

Item	Layer 1	Layer 2	Layer 3	Default
	SCHEDULE RESET	YES		
EXIT OSD	YES			

3.3 Configuration Menu

The detailed functions and parameter setting of your PTZ Camera can be set by the OSD (On Screen Display) menu with a control device such as a control keyboard. The tables below show each page of the OSD menu. Additionally, Appendix B provides a table for user's setting record.

To enter the OSD menu of the selected camera, press <CAMERA MENU> key on the control keyboard and hold for 3 seconds to enter the OSD menu.

To select the setup item, use direction keys on keyboard to move the OSD cursor in the OSD menu.

To setup item, use direction keys on keyboard to move the OSD cursor in the OSD menu. For items with →, press right/left direction keys on the control keyboard to select. For items with ↓, press the <CAMERA MENU> key on the control keyboard to enter the sub menu. For items with →↓, users can use the right/left direction keys to select functions, and then press the <CAMERA MENU> key on the control keyboard to enter their sub menu.

For further detailed setup procedures, please refer to the user's manual of your installed control devices.



NOTE: In the Camera OSD menu, the <CAMERA MENU> key functions as "ENTER" and "EXIT."

3.3.1 LANGUAGE

The camera supports multi-language OSD operation; the available languages include English, French, German, Italian, Portuguese and Spanish. As you select a language with the arrow keys on the Control Keyboard, the OSD menu will automatically change to the language you have selected. The default language is <ENGLISH>.

MAIN PAGE 1	
LANGUAGE	ENGLISH
DEFAULT CAMERA	ON
BACKLIGHT	OFF
FOCUS	AUTO
AE MODE	ENTER
WBC MODE	AUTO
SETUP MENU 1	ENTER
SETUP MENU 2	ENTER

3.3.2 DEFAULT CAMERA

The item is for restoring the camera settings, including Backlight, Focus, AE, WBC, Digital Zoom, Slow Shutter, Image Inverse and Aperture, to factory defaults. Once any one of the parameters mentioned above is modified, The DEFAULT CAMERA item will become <OFF> automatically. Select <ON> to recall these camera parameters to default settings.

3.3.3 BACKLIGHT

The Backlight Compensation function prevents the center object from being too dark in surroundings where excessive light is behind the center object. Set this item to <ON>; the center object will be brightened in contrast to the edge of the picture (where backlight would most likely be located).

3.3.4 FOCUS

The PTZ Camera's focus can be operated in two modes: Manual Focus mode and Auto Focus mode.

- **AUTO**

There are three options available for the AF Mode, including Normal mode, Zoom Trigger (Z. TRIG.) mode and PTZ Trigger (PTZ TRIG.) mode. The submenu of AF Mode is shown below:

AF MODE	NORMAL
EXIT + SAVE	YES

Normal Mode

In this mode, the camera will keep in focus automatically and continuously in any condition.

Zoom Trigger Mode

In this mode, AF is activated at the time when zoom is changed.

PTZ Trigger Mode

In this mode, AF is triggered when the PTZ Camera is manipulated to pan, tilt or zoom.

EXIT + SAVE

Press <YES> on this item to save the selected AF Mode.

- **MANUAL**
In this mode, users can adjust focus near/far via the control keyboard's Focus Near/Far key.

3.3.5 AE MODE

Exposure is the amount of light received by the image sensor and is determined by how wide you open the lens diaphragm (iris adjustment), by how long you keep the sensor exposed (shutter speed), and by other exposure parameters. With this item, users can define how the Auto Exposure (AE) function works.

- **EXPOSURE COMPENSATION**
The exposure value ranges from -10.5dB ~ 10.5dB. Select <OFF> to disable the function.
- **AE MODE**

AUTO

In this mode, the camera's Brightness, Shutter Speed, IRIS and AGC (Auto Gain Control) control circuits work together automatically to get consistent video output level.

SHUTTER

With this option, Shutter Speed takes main control of exposure, and both IRIS and AGC will function automatically in cooperation with shutter speed to achieve consistent exposure output. The shutter speed ranges from 1/10000 ~ 1/50.

IRIS

In this mode, the IRIS function adjusts exposure in higher property. SHUTTER speed and AGC circuit will function automatically in cooperating with IRIS to get consistent exposure output. The IRIS value is fixed at f1.6.

Manual

In the mode, users can adjust shutter speed (1/10000 ~ 1/50 for PAL; 1/10000 ~ 1/60 for NTSC) and gain value (-3dB ~ 28dB) for optimized video output.

- **EXIT**
Exit the AE MODE menu and go back to the **Main Page 1** to continue to

set the WBC mode.

MAIN PAGE 1	
LANGUAGE	ENGLISH
DEFAULT CAMERA	OFF
BACKLIGHT	OFF
FOCUS	AUTO
AE MODE	ENTER
WBC MODE	AUTO
SETUP MENU 1	ENTER
SETUP MENU 2	ENTER

3.3.6 WBC MODE

A digital camera needs to find reference color temperature, which is a way of measuring the color of a light source, for calculating all the other colors. The unit for measuring this ratio is in degree Kelvin (K). You can select one of the White Balance Control modes according to the installation condition. The following table shows the color temperature of some light sources.

Light Sources	Color Temperature in K
Cloudy Sky	6,000 to 8,000
Noon Sun and Clear Sky	6,500
Household Lighting	2,500 to 3,000
75-watt Bulb	2,820
Candle Flame	1,200 to 1,500

- AUTO**
 In this mode, white balance works within its color temperature range. This mode computes the white balance value output using color information from the entire screen.
- INDOOR**
 3200 K Base mode.
- OUTDOOR**
 5800 K Base mode.
- ATW (Auto Tracing White Balance)**
 The PTZ Camera takes out the signals in a screen in the range from 2000 K to 10000 K.

- **MANUAL**

In this mode, users can change the White Balance value manually; R gain and B gain are adjustable and range from 0 to 127.

WBC MENU	
R GAIN	50
B GAIN	50
EXIT + SAVE	YES

3.3.7 SETUP MENU 1

The SETUP MENU 1 is shown below.

SETUP MENU 1	
ZOOM SPEED	8
DIGITAL ZOOM	OFF
SLOW SHUTTER	OFF
D.N.R.	ENTER
IMAGE INVERSE	OFF
FREEZE	OFF
APERTURE	07
EXIT	YES

The zoom speed of the PTZ Camera is fixed (Value: 8). Users could choose whether to activate functions including Digital Zoom, Slow Shutter, Noise Reduction, Image Inverse and Image Freeze. Refer to the following description for use of each function.

- **DIGITAL ZOOM**

With this item, users can enable or disable the 12× Digital Zoom. The Digital Zoom will start to activate after the full Optical Zoom level is reached. Maximum 12× digital zoom function is allowed to be enabled. The default setting is <ON>.



NOTE: The difference between optical and digital zoom is that optical zoom uses the lens within the camera to draw the image closer via zoom in or out to achieve the desired effect. Optical zoom remains the same resolution of the zoomed image quality. On the other hand, Digital zoom takes a portion of image and expands that image to the full size of the image; the image quality will be reduced.

- **SLOW SHUTTER**

The shutter speed determines how long the image sensor is exposed to light. The PTZ Camera will automatically adjust the shutter speed basing on the light condition of the operating environment. With Slow Shutter

function, users can see clear image in low light conditions under 0.1 lux.

- **DIGITAL NOISE REDUCTION (D.N.R.)**

With 2D / 3D Noise Reduction, the processor analyzes pixel by pixel and frame by frame to eliminate environmental noise signal so that the highest quality image can be produced even in low light conditions. In comparison with 2D D.N.R., 3D D.N.R generates better denoising effects.

- **IMAGE INVERSE**

Users can select <ON> to make the displayed image inversed vertically and horizontally (see the figures shown below). Occasions to employ the function include conferences, demonstration, testing, etc. The default setting is <OFF>. When this function is enabled, the preset mask(s) will be set off automatically.

Application: Users can see the displayed images, as shown below, when a PTZ Camera is placed on the desk top in a conference, for instance.

IMAGE INVERSE (OFF)



IMAGE INVERSE (ON)



- **FREEZE**

Freeze function allows to hold the image while the camera is moving between preset positions such as in PRESET (see section 3.3.12) and SEQUENCE (see section 3.3.13) modes. For example, when the PTZ Camera is manipulated to run from point A to point B, if the Freeze function is activated, the first view that users would see is point A. Then the next view would directly change to point B, without displaying the moving path.

- **APERTURE**

Users can adjust enhancement of the edges of objects in the picture. There are 16 levels of adjustment; the options are <01> ~ <16>; <01> represents “no enhancement”. When shooting text, this function could make it sharp.

- **EXIT**

Exit the SETUP MENU 1 and go back to the **MAIN PAGE 1** to set other functions under the setup menu 2.

MAIN PAGE 1	
LANGUAGE	ENGLISH
DEFAULT CAMERA	OFF
BACKLIGHT	OFF
FOCUS	AUTO
AE MODE	ENTER
WBC MODE	AUTO
SETUP MENU 1	ENTER
SETUP MENU 2	ENTER

3.3.8 SETUP MENU 2

The SETUP MENU 2 is as shown below.

SETUP MENU 2	
FLIP	ENTER
ANGLE ADJUSTER	ENTER
SPEED BY ZOOM	OFF
AUTO CALI.	OFF
PASSWORD	OFF
OSD AUTO CLOSE	20 SEC
SYSTEM RESET	ENTER
EXIT	YES

- **FLIP**

Users can track an object continuously when it passes through under the PTZ Camera with setting Flip to IMAGE (digital flip) or M.E. (mechanical flip).

FLIP SETTING	
FLIP	OFF
EXIT+ SET	YES

IMAGE

IMAGE represents digital IMAGE FLIP, which enables users to keep tracking objects seamlessly; under the mode, almost no delay occurs in comparing with that under the M.E. mode.



NOTE: The Privacy Mask function will be automatically disabled if the Image Flip function is enabled, and the screen will show “MASK WILL BE SET OFF.”

M.E.

M.E. is a standard mechanical operation. As the Camera tilts to the maximum angle, it will pan 180°, and then continue tilting to keep tracking objects.

OFF

Select this item to disable the flip function.



NOTE: To make the PTZ Camera tilt between a specific range, such as -10° to +100°, please go to **ANGLE ADJUSTER** (see next section) to set the angle range of tilt. Otherwise, the camera will tilt 90° as the default setting.

- **ANGLE ADJUSTER**

The item is for adjusting the camera view angle. The range of view angle is between -10° and +100°.

ANGLE ADJUSTER	
ADJUST MIN ANGLE	-10 DEG
ADJUST MAX ANGLE	100 DEG
EXIT+SET	YES

- **SPEED BY ZOOM**

If the item is set to <ON>, the pan/tilt speed will be adjusted by internal algorithm when zooming automatically. The larger zoom ratio leads to the lower rotation speed.

- **AUTO CALI. (Auto Calibration)**

There are one horizontal and one vertical infrared ray check points in each PTZ Camera. When the PTZ Camera's position is moved during installation or maintenance, the relative distance between the original set point and the check point could be changed. Enable the Auto Calibration function, the camera will automatically detect the distance change and reset the point back to the original position.

- **PASSWORD**

The administrator can activate OSD Password function for security concerns. Once the function is turned on, users are required to enter the password every time when accessing to the OSD menu. The Password setting menu is shown below:

```

NEW PASSWORD:: -----
CONFIRM PASSWORD:: -----

0123456789

← SAVE EXIT

```

The password setting procedure is like the following:

STEP 1: Choose a number with direction keys and then press the **<CAMERA MENU>** key (ENTER) to input. For example: **<0>** **<CAMERA MENU>**, **<1>** **<CAMERA MENU>**, **<2>** **<CAMERA MENU>**, **<3>** **<CAMERA MENU>**.

PASSWORD: 0123

STEP 2: In the second line, enter the same password again to confirm the setting.

STEP 3: Move the cursor to **<SAVE>** and press **<CAMERA MENU>** to save the setting.

STEP 4: Move the cursor to **<EXIT>** and press **<CAMERA MENU>** to exit the password setting page.

If OSD Password function is enabled, when press the **<CAMERA MENU>** key to enter the OSD menu, the password request message will be displayed as shown below. Please enter the password, press **<ENTER>** and then access to the OSD main menu.

```

PLEASE ENTER PASSWORD

-----

0123456789
← ENTER EXIT

```

- **OSD AUTO CLOSE**

Users can specify the duration for OSD menu to stay on the screen. Time selection ranges from 5 ~ 30 seconds. To keep the OSD menu stay on the screen, please set this option to "OFF".

- **SYSTEM RESET**

Two types of system reset can be implemented under this item:

SYSTEM RESET

Select this function for system reboot. Press "ENTER" and system reboot will start up.

DEFAULT SYSTEM

This function allows users to restore the camera to its factory default state. Press "ENTER" and reset will start up.

- **EXIT**

Exit the SETUP MENU 2 and go to the **MAIN PAGE 2** to carry on setting other functions.

MAIN PAGE 2	
ID DISPLAY	ON
TITLE DISPLAY	OFF
TITLE SETTING	01
PRESET	ENTER
SEQUENCE	ENTER
AUTOPAN	ENTER
CRUISE	ENTER
HOME SETTING	ENTER

3.3.9 ID DISPLAY

Users are allowed to choose whether the PTZ Camera's ID will be displayed on the monitor to identify each PTZ Camera. For PTZ Camera's ID setting, please refer to section [2.4 ID Setup \(Analog Model\)](#).

- **ON**

Display the ID of the selected PTZ Camera on the right bottom of the monitor screen.

- **OFF**

Hide the ID of the selected PTZ Camera.

3.3.10 TITLE DISPLAY

Users are allowed to name a certain view area and display its title for easy recognition. With this item, users can choose to display or not to display the titles set in advance.

- **ON**

A title set for certain view will be displayed when the PTZ Camera stays in the view area.

- **OFF**

When the TITLE DISPLAY is set <OFF>, no title will be displayed on the screen even titles are set in advance.

3.3.11 TITLE SETTING

Up to 16 zone titles can be set with maximum 20 characters for each title.

Follow the steps to set a camera title.

STEP 1: Operate the PTZ Camera to a view area where you want to set a title for it.

STEP 2: Turn on the OSD and go to the **MAIN PAGE 2** to select <TITLE SETTING>.

STEP 3: Select a number to represent the view area.

STEP 4: Press the <**CAMERA MENU**> key (ENTER) to go into the editing page.

TITLE SETTING: 01											
0	1	2	3	4	5	6	7	8	9		EXIT
A	B	C	D	E	F	G	H	I	J		SAVE
K	L	M	N	O	P	Q	R	S	T		LEFT
U	V	W	X	Y	Z	:	/	.	,		RIGHT
[]	+	?	-							DELETE
TITLE:											
ABC											

STEP 5: Choose a character with direction keys and then press the <**CAMERA MENU**> key (ENTER) to input. For example: <A> <**CAMERA MENU**>, <**CAMERA MENU**>, <C> <**CAMERA MENU**>

TITLE: ABC

STEP 6: To delete input characters, move the cursor to <LEFT> or <RIGHT> and press <**CAMERA MENU**> to select a character in the entry field. Then move the cursor to <DELETE> and press <**CAMERA MENU**> to delete the selected character.

STEP 7: When the setting is completed, move the cursor to <SAVE> and press <ENTER> to save.

After completing tile setting, go back to the **MAIN PAGE 2** to carry on setup of preset points.

MAIN PAGE 2	
ID DISPLAY	ON
TITLE DISPLAY	OFF
TITLE SETTING	01
PRESET	ENTER
SEQUENCE	ENTER
AUTOPAN	ENTER
CRUISE	ENTER
HOME SETTING	ENTER

3.3.12 PRESET

- **PRESET SET**

Totally 256 preset points can be set. Follow the steps below when in the preset setting menu.

STEP 1: Press the right/left key on the keyboard to select a number (1 represents preset point 1, 2 represents preset point 2, etc.)

STEP 2: Press the <**CAMERA MENU**> key (ENTER) on the keyboard, and then rotate the PTZ Camera to a targeted shooting area/point.

STEP 3: Press the <**CAMERA MENU**> key again to save the defined preset point.

Once completing setup of a preset point, users could move the cursor to the next item to run the preset point.

- **PRESET RUN**

Select the preset point that you want to execute. After pressing "ENTER", the camera will turn to the appointed point.

- **EXIT**

Exit the PRESET menu and go back to the **MAIN PAGE 2** to carry on setup of sequence.

MAIN PAGE 2	
ID DISPLAY	ON
TITLE DISPLAY	OFF
TITLE SETTING	01
PRESET	ENTER
SEQUENCE	ENTER
AUTOPAN	ENTER
CRUISE	ENTER
HOME SETTING	ENTER



NOTE: Users could set preset points through a keyboard. Please refer to the control keyboard's quick guide for further information.

3.3.13 SEQUENCE

The function executes pre-positioning of the pan, tilt, zoom and focus features in a certain sequence for a camera. Before setting this function, users must preset at least two preset points.

SEQUENCE	
SEQUENCE LINE	1
SEQUENCE POINT	01
PRESET POSITION	001
SPEED	01
DWELL TIME	001
RUN SEQUENCE	ENTER
EXIT	YES

- **SEQUENCE LINE**

There are eight sets of sequence lines built in the PTZ Camera. Using LEFT/RIGHT direction keys to select a line first and then set its sequence points.

- **SEQUENCE POINT**

Up to 64 points can be specified for each sequence line. The sequence points represent order of the preset points that the PTZ Camera will automatically run. The following setup items, including PRESET POSITION, SPEED and DWELL TIME, will influence how the camera runs through each sequence point.

- **PRESET POSITION**

Users can assign a specific preset position to the selected sequence point with this item.

- **SPEED**

Users can set the speed of one sequence point to the next one, and the range of setup speed is from 1 to 15. Within the range, PAN and Tilt speed varies from 5 ~ 300(degree/sec.)

- **DWELL TIME**

The DWELL TIME is the duration time that the PTZ Camera will stay at a sequence point, and the range is from <0> to <127> seconds. The PTZ Camera will go to the next sequence point when the DEWEL TIME expires. If the setting is <0>, the PTZ Camera will stay at this sequence point until users manually move the camera.

- **RUN SEQUENCE**

Users can command the PTZ Camera to run the selected sequence line manually.

- **EXIT**

Select the item to exit the SEQUENCE menu; go back to the **MAIN PAGE 2** to carry on setup of auto-pan.

MAIN PAGE 2	
ID DISPLAY	ON
TITLE DISPLAY	OFF
TITLE SETTING	01
PRESET	ENTER
SEQUENCE	ENTER
AUTOPAN	ENTER
CRUISE	ENTER
HOME SETTING	ENTER



NOTE: Users could execute the sequence function through a keyboard. Please refer to the control keyboard's quick guide for further information.

3.3.14 AUTOPAN

Auto-pan means motion of scanning an area horizontally so that the PTZ Camera can catch horizontal view. The parameters are listed as follows.

AUTOPAN	
AUTOPAN LINE	1
START POINT	TO FIND
END POINT	TO FIND
DIRECTION	RIGHT
SPEED	01
RUN AUTOPAN	ENTER
EXIT	YES

- **AUTOPAN LINE**

There are four sets of auto-pan line built in a PTZ Camera. Users can choose a line to execute using LEFT/RIGHT direction keys. In addition, users are able to command the PTZ Camera to do endless panning by setting the start point the same as the end point.

- **START POINT**

Follow the description below to set the start position of the AUTOPAN path.

1. Move the cursor to <START POINT> and press <ENTER> while the item, <TO FIND>, is flashing. Then the item will turn <TO SAVE> automatically.

2. Move the PTZ Camera to a desired position and press <ENTER> to save the position as the start point; the cursor will move to <END POINT> automatically. Ensure setting the end point to complete auto-pan setting.



NOTE: The tilt and zoom values of the start point will be recorded and fixed for the selected auto-pan line.

- **END POINT**

Users are able to set the end point after the start point is defined. Pan the PTZ Camera to another position and press <ENTER> to save the position as the end point.

- **DIRECTION**

The item is for setting the AUTOPAN direction of the PTZ Camera. The camera will start to pan clockwise from the start point to the end point if your selection is <RIGHT>, and then return to the start point. The PTZ Camera will start to pan anti-clockwise from the start point to the end point if your selection is <LEFT>. Refer to the diagram below.

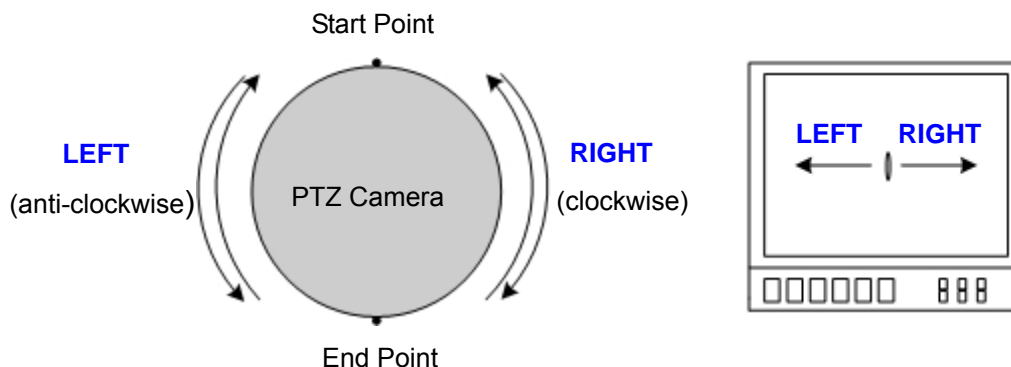

- **SPEED**

The item is for defining the PTZ Camera rotation speed while running auto-pan. The speed is adjustable from 1 to 4 (10 ~ 45 degree/sec.).

- **RUN AUTOPAN**

After all setting related to auto-pan are completed, select this item to execute the Auto-pan function.

- **EXIT**

Exit the AUTOPAN setup menu; go back to the **MAIN PAGE 2** to carry on setup of cruise.

MAIN PAGE 2	
ID DISPLAY	ON
TITLE DISPLAY	OFF
TITLE SETTING	01
PRESET	ENTER
SEQUENCE	ENTER
AUTOPAN	ENTER
CRUISE	ENTER
HOME SETTING	ENTER



NOTE: Users could execute the auto-pan function through a keyboard. Please refer to the control keyboard's quick guide for further information.

3.3.15 CRUISE

CRUISE is a route formed with manual operation, through adjusting pan and tilt position, which can be stored and recalled to execute repeatedly.

CRUISE	
CRUISE LINE	1
RECORD START	ENTER
RECORD END	ENTER
RUN CRUISE	ENTER
EXIT	YES

- **CRUISE LINE**

There are eight sets of Cruise line built in a PTZ Camera. Using LEFT/RIGHT direction keys to select a line first and then follow the steps below to start recording the cruise path.

- **RECORD START**

Follow the description below to record the CRUISE path.

1. Rotate the PTZ Camera to a desired view area (for some protocols, users may need to do it before entering the OSD), and press <ENTER> to build the cruise path using the joystick on the control device. The percentage of the memory buffer will be displayed on the screen.
2. Pan and tilt the PTZ Camera to form a path.



NOTE: Beware of the memory size when building a cruise path. Once the buffer percentage reaches 100%, recording of the path will stop.

- **RECORD END**

The cursor will be moved to RECORD END while building the cruise line; when the setting is completed, press <ENTER> to save the path.

- **RUN CRUISE**

After Cruise setting is completed, select this item to execute the Cruise function.

- **EXIT**

Exit the CRUISE setup menu ; go back to the **MAIN PAGE 2** to carry on setup of home setting.

MAIN PAGE 2	
ID DISPLAY	ON
TITLE DISPLAY	OFF
TITLE SETTING	01
PRESET	ENTER
SEQUENCE	ENTER
AUTOPAN	ENTER
CRUISE	ENTER
HOME SETTING	ENTER



NOTE: Users could execute the cruise function through a keyboard. Please refer to the control keyboard's quick guide for further information.

3.3.16 HOME SETTING

Users are able to set an operation mode to ensure constant monitoring; if the PTZ Camera idles for a period of time, the selected function will be activated automatically. HOME function allows constant and accurate monitoring to avoid the PTZ Camera stopping or missing events.

HOME SETTING	
HOME FUNCTION	OFF
SELECT MODE	PRESET
PRESET POINT	001
RETURN TIME	001 MIN.
GO	ENTER
EXIT	YES

- **HOME FUNCTION**

The item is used to enable or disable the HOME function. Use the left/right direction keys of the control keyboard to change the setting.

- **SELECT MODE**

Select one of the modes that the PTZ Camera should execute when HOME function is enabled and the RETURN TIME is up. The options include <AUTOPAN>, <SEQUENCE>, <CRUISE> and <PRESET>. Use the left/ right direction keys on the control keyboard to change the setting, and the items mentioned below will change in cooperating with your selection.

PRESET POINT

Select a Preset Point where the PTZ Camera should go after the Return Time function, which will be mentioned later, is activated. The preset point(s) should be set prior either in the PRESET setup menu or through the keyboard.

SEQUENCE LINE

Select a Sequence Line that the PTZ Camera should execute when an alarm pin is triggered. The Sequence Line(s) should be defined previously in the SEQUENCE setup menu.

AUTOPAN LINE

Select an Auto-pan Line that the PTZ Camera should execute when an alarm pin is triggered. The Auto-pan Line(s) can be defined in the AUTOPAN setup menu.

CRUISE LINE

Select a Cruise Line that the PTZ Camera should execute when an alarm pin is triggered. The Cruise Line(s) can be defined in the CRUISE setup menu.

- **RETURN TIME**

The PTZ Camera starts to count down RETURN TIME when the camera idles, and it will execute the SELECT MODE function if the return time is up. The RETURN TIME ranges from 1 to 128 minutes.

- **GO**

If HOME function is enabled, the users are allowed to execute HOME function manually by selecting this item.

- **EXIT**

Exit the HOME SETTING menu. Then go to the **MAIN PAGE 3** to carry on other setups.

MAIN PAGE 3	
IR FUNCTION	AUTO
ALARM SETTING	ENTER
ALARM DETECT	NONE
WDR FUNCTION	OFF
PRIVACY MASK	ENTER
TIME SETTING	ENTER
SCHEDULE	ENTER
EXIT OSD	YES

3.3.17 IR FUNCTION

With the IR cut filter, the PTZ Camera can still catch clear image at night time or in the very dark light condition. During day time, the IR cut filter will be on to block the infrared light for clear image; during night time or in dark light condition, the IR cut filter will be removed to catch infrared light, and the displayed images will become black and white.

- **AUTO**

The Internal circuit will automatically decide the occasion to remove the IR cut filter according to the value of light condition calculated by the internal light algorithm. The options include <LOW>, <MID> and <HI>. <LOW> indicates a higher sensitivity and can improve reliability of lens so that it is easier to switch to Day mode and relatively difficult to change into Night mode; while <HI> indicates that it is easier to switch to Night mode and difficult to change into Day mode.

- **MANUAL**

IR MANUAL ON

Select the item to remove the IR cut filter; the camera will be in B/W (Night) mode.

IR MANUAL OFF

Select the item to attach the IR cut filter; the camera will be in Color (Day) mode to disable the IR function.

3.3.18 ALARM SETTING

The Mini PTZ Camera provides eight alarm inputs and one alarm output (N.O. and N.C) to connect alarm devices. With this function, the PTZ Camera will cooperate with alarm system to catch the event images. For wiring, please refer to the installation guide and/or qualified service personnel. Adjustable alarm parameters are listed below.

ALARM SETTING	
ALARM PIN	1
ALARM SWITCH	OFF
ALARM TYPE	NC
ALARM ACTION	PRESET
PRESET POINT	001
DWELL TIME	ALWAYS
EXIT	YES

- **ALARM PIN**

The PTZ Camera provides 8 alarm inputs and 1 relay output (1× N.O. and 1× N.C.). Select an alarm pin which you want to set its alarm-related parameters, and then set its alarm-related parameters in the Alarm Setting menu. For alarm pin definitions, please refer to section [2.6 22-Pin Connector Definition](#) or the installation guide.



NOTE: If two or more alarm pins are triggered at the same time, smaller alarm pin number will have higher priority of being handled. For example, if Alarm-1 and Alarm-3 are triggered simultaneously, only Alarm-1 will actually be handled.

- **ALARM SWITCH**

The item is used to enable or disable the selected alarm pin function. Use the left/right direction keys on the control keyboard to change the setting.

- **ALARM TYPE**

There are two kinds of alarm types: Normal Open and Normal Close, which are illustrated as below. Select an alarm type that corresponds with the alarm application.

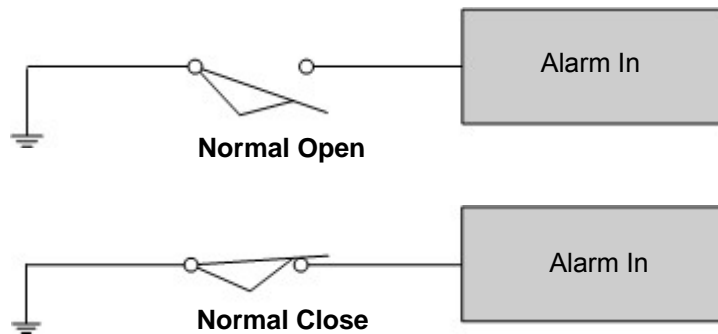

- **ALARM ACTION**

The alarm actions include PRESET, SEQUENCE, AUTOPAN and CRUISE functions. Select one of these modes so that certain action will be executed when an alarm is triggered. Use the right direction key of the control keyboard to select a particular action mode, and the items listed below will change in accordance with your selected alarm action. Additionally, when an alarm is triggered, there will be a flash warning notice: ALARM displayed in the upper right corner of the screen.

- **PRESET POINT**

Select a Preset Point where the PTZ Camera should go when an alarm pin is triggered. The preset point(s) should be set prior either in the PRESET setup menu or through the keyboard.

SEQUENCE LINE

Select a Sequence Line that the PTZ Camera should execute when an alarm pin is triggered. The sequence line(s) should be defined prior either in the SEQUENCE setup menu or through the keyboard.

AUTOPAN LINE

Select an Auto-pan Line that the PTZ Camera should execute when an alarm pin is triggered. The Auto-pan Line(s) should be defined prior either in the AUTOPAN setup menu or through the keyboard.

CRUISE LINE

Select a Cruise Line that the PTZ Camera should execute when an alarm pin is triggered. The Cruise Line(s) should be defined prior either in the CRUISE setup menu or through the keyboard.

- **DWELL TIME**

The DWELL TIME is duration of executing an alarm action. If select the PRESET mode is selected, when alarm takes place, the PTZ Camera will go to the selected preset position and stay there for a user-defined period of time (1~127seconds/Always) when alarm takes place. If select other modes (SEQUENCE/AUTOPAN/CRUISE) have been selected, the camera will keep executing the selected mode (DWELL TIME: ALWAYS) until alarm condition is released or users rotate the joystick to change the status of the PTZ Camera.



NOTE: The dwell time is only adjustable when selecting **Preset** as the alarm action. When the dwell time is up, the PTZ Camera will go back to its trigger position and recheck alarm pin status.

- **EXIT**

Exit the ALARM SETTING menu and go back to the **MAIN PAGE 3** to carry on Privacy Mask setup.

MAIN PAGE 3	
IR FUNCTION	AUTO
ALARM SETTING	ENTER
ALARM DETECT	NONE
WDR FUNCTION	OFF
PRIVACY MASK	ENTER
TIME SETTING	ENTER
SCHEDULE	ENTER
EXIT OSD	YES

3.3.19 ALARM DETECT

When the Alarm Detect function is activated, the camera will detect movement within a monitoring area and then send an alarm signal automatically. There will be a flash warning notice: MOTION displayed in the upper left corner of the screen.

ALARM DETECT	
DETECT SWITCH	OFF
DETECT MODE	NONE
BLOCK MODE	NONE
FRAME SET	NONE
FRAME DISABLE	NONE
THRESHOLD	NONE
EXITD	YES

- **DETECT SWITCH**

The item is used to enable or disable the ALARM DETECT function.

- **BLOCK MODE**

In Motion Detect Mode, users can set Block Mode as “ON” or “OFF”. When BLOCK MODE is turned on, if there are any variations (e.g. caused by intrusion) in the sections of the monitoring image, the affected parts will be highlighted dynamically.

- **FRAME SET**

In a monitored field, users can define specific areas as motion detection target zones. Please refer to the instructions as follows to configure parameters for each motion detection zone so-called “Frame.” When motion is detected within a defined frame, a flash warning notice: MOTION, will display in the upper left corner of the screen.

Total four frames can be set. Select a frame using the right/left keys on the keyboard, and press “ENTER” key to enter the frame’s submenu, as shown below.

FRAME SET 1	
LEFT LIMIT	L/R
TOP LIMIT	D/U
H SIZE	000
V SIZE	000
MODE	PRESET
PRESET POINT	001
DWELL TIME	001 SEC
EXIT	YES

LEFT LIMIT

Move the frame right/left using the right/left keys on the keyboard.

TOP LIMIT

Shift the frame up/down using the right/left keys on the keyboard.

H/V SIZE

Adjust the frame size via changing H/V size value using the right/left keys on the keyboard.

MODE

Assign a trigger action for a motion detection frame. Options include PRESET, SEQUENCE, AUTOPAN and CRUISE. When motion is detected within a frame, the PTZ Camera will execute the specific trigger action.

DWELL TIME

The DWELL TIME is duration of executing a trigger action. If select the PRESET mode, when motion is detected, the PTZ Camera will go to the selected Preset position and stay there for a user-defined period of time (1~127 seconds/Always). If select other modes (SEQUENCE/AUTOPAN /CRUISE), the PTZ Camera will keep executing the selected mode (DWELL TIME: ALWAYS) until it is interrupted by commands sent from a connected control device.

EXIT

Exit the FRAME setting page and go back to ALARM DETECT main page.

- **FRAME DISABLE**
Select a frame to be canceled, and press "ENTER." The selected frame will then be removed from the monitored field.
- **THRESHOLD**
The Threshold range is adjustable from 1~255. The smaller the value, the more sensitive it is; i.e. 1: highest sensitivity; 255: lowest sensitivity.
- **EXIT**
Exit the ALARM DETECT menu and go back to the **MAIN PAGE 3** to carry on setup of WDR function (see [3.3.20 WDR FUNCTION](#)).

3.3.20 WDR FUNCTION

The Wide Dynamic Range (WDR) function is especially effective in solving indoor and outdoor contrast issues to enhance better image quality and video display. It enables the PTZ Camera to catch detailed data from the dark part (Indoor) without any saturation from the bright part (Outdoor).



NOTE: The Backlight function will be turned off automatically when the WDR function is enabled because the WDR function has better effects than Backlight Compensation.

- **ON**
Activate the WDR function by selecting this option. In this mode, the PTZ Camera will operate the WDR function automatically.
- **OFF**
Deactivate the WDR function.

Exit the WDR FUNCTION menu and go back to the **MAIN PAGE 3** to carry on setup of Privacy Mask.

MAIN PAGE 3	
IR FUNCTION	AUTO
ALARM SETTING	ENTER
ALARM DETECT	NONE
WDR FUNCTION	OFF
PRIVACY MASK	ENTER
TIME SETTING	ENTER
SCHEDULE	ENTER
EXIT OSD	YES

3.3.21 PRIVACY MASK

The Privacy Mask function aims to avoid any intrusive monitoring. Users can adjust the camera view position using the joystick, and adjust the mask size and area via the direction keys on the control keyboard. When setting a mask, it is suggested to set it at least *twice bigger* (height and width) than the masked object. The PTZ Camera will assume the center of the selected view as an starting point, and the joystick will be locked as users enter the SET MASK menu (mentioned later). Refer to the following description for setting privacy masks.



NOTE: The Image Flip function and the Image Inverse function will be disabled automatically while the Privacy Mask function is enabled.

The available area for setting a privacy mask is restricted within tilt angle 70 degrees. Maximum 8 masks can be displayed in one scene. All the settings are described as the following:

PRIVACY MASK MENU	
PRIVACY SWITCH	OFF
TRANSPARENCY	OFF
COLOR	BLACK
SET MASK	01
CLEAR MASK	01
EXIT	YES

- PRIVACY SWITCH**

Users can enable or disable the Privacy Mask function through this item. Set this item to <ON> before configuring mask zones.
- TRANSPARENCY**

The color of privacy mask can be set as transparent. Select <ON> to display transparent masks.
- COLOR**

The color of privacy mask can be set through this item. The available colors are black, white, red, green, blue, cyan, yellow and magenta.
- SET MASK**

Use the control device to move the PTZ Camera to the area where you want to set a mask. Press <ENTER> to enter the SET MASK menu. The PTZ Camera will memorize the present position as a privacy mask position. Up to 16 masks can be set.

MASK01 MENU	
H CENTER	L/R
V CENTER	D/U
H SIZE	000
V SIZE	000
EXIT+SAVE	YES

H CENTER

The original horizontal center of a mask zone is the center of a screen; it is able to move a mask zone to the other position by adjusting the horizontal value with the LEFT/RIGHT keys on the keyboard. The camera will pan right or left according to user's control.

V CENTER

The original vertical center of a mask zone is the center of a screen; it is able to move a mask zone to the other position by adjusting the vertical value with the LEFT/RIGHT keys on the keyboard. The camera will tilt up or down according to user's control.

H SIZE (00~80)

Users can adjust the horizontal size of a privacy mask through this item. Set the H and V size to 0 can also delete the selected mask.

V SIZE (00~60)

Users can adjust the vertical size of a privacy mask through this item. Set the H and V size to 0 can also delete the selected mask.

- **CLEAR MASK**

Users can delete a preset mask zone with this item. Please follow the steps listed below.

1. Select the mask zone that will be erased (e.g. 01).
2. Press <ENTER> to confirm the selection.

- **EXIT**

Exit the PRIVACY MASK menu and go back to the **MAIN PAGE 3** to carry on time related setup.

MAIN PAGE 3	
IR FUNCTION	AUTO
ALARM SETTING	ENTER
ALARM DETECT	NONE
WDR FUNCTION	OFF
PRIVACY MASK	ENTER
TIME SETTING	ENTER
SCHEDULE	ENTER
EXIT OSD	YES

3.3.22 TIME SETTING

The time setting function is used to set the TIME related parameters of the PTZ Camera. Each item in the menu is listed as follows.

TIME SETTING	
TIME DISPLAY	OFF
SET YEAR	00
SET MONTH	01
SET DAY	00
SET HOUR	00
SET MINUTE	00
EXIT+SAVE	YES

- **TIME DISPLAY**

Select <ON> to display Time information on the screen or <OFF> not to display.

- **YEAR / MONTH / DAY**

The items are for setting up the system date.

- **HOUR / MINUTE**

The items are for setting up the system time.

- **EXIT+SAVE**

Exit the TIME SETTING menu and go back to the **MAIN PAGE 3** to carry on setup of schedule.

MAIN PAGE 3	
IR FUNCTION	AUTO
ALARM SETTING	ENTER
ALARM DETECT	NONE
WDR FUNCTION	NONE
PRIVACY MASK	ENTER
TIME SETTING	ENTER
SCHEDULE	ENTER
EXIT OSD	YES

3.3.23 SCHEDULE FUNCTION

The schedule function enables users to program a preset point or function (Sequence/Auto-pan/Cruise) automatically to perform in a specific period of time.

SCHEDULE	
SWITCH	OFF
POINT	00
HOUR	00
MINUTE	00
MODE	PRESET
PRESET POINT	001
SCHEDULE RESET	YES
EXIT	YES

- **SCHEDULE SWITCH**

Select <ON> to enable or <OFF> to disable the schedule function.

- **SCHEDULE POINT**

Users are allowed to arrange 32 sets of schedule point, i.e. each set of schedule point can be assigned one kind of schedule modes.

- **SCHEDULE HOUR / MINUTE**

The items are for setting up the time to execute each schedule point.

- **SCHEDULE MODE**

This is for setting the schedule function of the selected schedule point; the options are listed as follows.

NONE

No action will be executed for the schedule if select the item.

PRESET

Users can select the PRESET mode as an action carried out in a schedule point.

SEQUENCE

Users can select the SEQUENCE mode as an action carried out in a schedule point.

AUTOPAN

Users can select the AUTOPAN mode as an action carried out in a schedule point.

CRUISE

Users can select the CRUISE mode as an action carried out in a schedule point.

IR FUNC. (IR Function)

If the IR function mode is selected, the AUTO IR FUNCTION will be activated for a schedule point.

- **SCHEDULE RESET**

Users can reset the whole schedule with the item.

- **SCHEDULE EXIT**

Exit the SCHEDULE menu and go back to the **MAIN PAGE 3**.

3.3.24 EXIT OSD

To exit the OSD setup menu, users can either select this item on the bottom of **MAIN PAGE 3** or press the ESC key on the control keyboard.

Appendix A: Technical Specification

Items		Indoor Mini PTZ Camera
CAMERA		
CCD Sensor		1/4" EXview CCD
Optical Zoom		12x
Digital Zoom		1× ~ 12× variable
Effective Pixels	NTSC	380k
	PAL	440k
Horizontal Resolution		540 TVL
Scanning System		NTSC / PAL
Synchronization		Internal / Line Lock
Video Output		1.0 Vp-p / 75 Ω, BNC
Minimum Illumination		0.1 lux; 0.01 lux (B/W)
Focal Length		3.8 ~ 45.6 mm
Focus Mode		Auto / Manual
White Balance		Auto / Manual / Indoor / Outdoor
Iris Control		Auto / Manual
Electronic Shutter		1/1 ~ 1/10k sec.
AGC control		Auto / Manual
Back Light Compensation		On / Off
OPERATION		
Built-in Protocol		DynaColor, Pelco D&P, VCL, Philips, AD-422, JVC, etc.
Multi-Language OSD		English, French, German, Italian, Portuguese, Spanish
Pan Travel		360° endless
Tilt Travel		-10° ~ 190°
Manual Speed		1° ~ 80°/s
Presets		256
Preset Accuracy		0.225°
Preset Speed		10° ~ 400°/s
Sequence		8
Auto Pan		4
Cruise		8
Privacy Mask		16
Proportional Pan & Tilt		On/Off (Pan and tilt speed proportional to zoom ratio)
Resume after Power loss		Yes
Zone Title		16
Home Function		Preset, Sequence, Auto pan, Cruise
Auto Flip		Digital / Mechanical / Off
Digital Slow Shutter		On / Off

Motion Detection		On / Off
Wide Dynamic Range		On / Off
Day/Night: IR Cut Filter		On / Off
Image Freeze		On / Off
Image Inverse		On / Off
Noise Reduction	2D	On / Off
	3D	On / Off
Alarm Input		8
Alarm Output		1
Alarm Reaction		Preset, Sequence, Auto pan, Cruise
GENERAL		
Environment		Indoor
Controller Interface		RS-485
Operating Temperature		0°C ~ 40°C (32°F ~ 104°F)
Dimension		∅131 x 200 mm (5.2 x 7.9 Inches)
Weight		1.2 kg (2.6 lbs)
Power Source		DC12V / AC24V ± 10%
Power Consumption		14 W
Regulatory		CE, FCC, RoHS

****Motion Detection function is available in 2010 Q3.**

****All Specifications are subject to change without notice.**

Appendix B: Switch Settings Index Table

Please refer to the switch settings below for Mini PTZ Camera's ID and protocol setup.

Camera ID Setup

ID No.	SWITCH SETTING									
	SW-1	SW-2	SW-3	SW-4	SW-5	SW-6	SW-7	SW-8	SW-9	SW-10
0	OFF	OFF	OFF	OFF	OFF	OFF	OFF	OFF	OFF	OFF
1	ON	OFF	OFF	OFF	OFF	OFF	OFF	OFF	OFF	OFF
2	OFF	ON	OFF	OFF	OFF	OFF	OFF	OFF	OFF	OFF
3	ON	ON	OFF	OFF	OFF	OFF	OFF	OFF	OFF	OFF
4	OFF	OFF	ON	OFF	OFF	OFF	OFF	OFF	OFF	OFF
5	ON	OFF	ON	OFF	OFF	OFF	OFF	OFF	OFF	OFF
6	OFF	ON	ON	OFF	OFF	OFF	OFF	OFF	OFF	OFF
7	ON	ON	ON	OFF	OFF	OFF	OFF	OFF	OFF	OFF
8	OFF	OFF	OFF	ON	OFF	OFF	OFF	OFF	OFF	OFF
9	ON	OFF	OFF	ON	OFF	OFF	OFF	OFF	OFF	OFF
10	OFF	ON	OFF	ON	OFF	OFF	OFF	OFF	OFF	OFF
11	ON	ON	OFF	ON	OFF	OFF	OFF	OFF	OFF	OFF
12	OFF	OFF	ON	ON	OFF	OFF	OFF	OFF	OFF	OFF
13	ON	OFF	ON	ON	OFF	OFF	OFF	OFF	OFF	OFF
14	OFF	ON	ON	ON	OFF	OFF	OFF	OFF	OFF	OFF
15	ON	ON	ON	ON	OFF	OFF	OFF	OFF	OFF	OFF
16	OFF	OFF	OFF	OFF	ON	OFF	OFF	OFF	OFF	OFF
17	ON	OFF	OFF	OFF	ON	OFF	OFF	OFF	OFF	OFF
18	OFF	ON	OFF	OFF	ON	OFF	OFF	OFF	OFF	OFF
19	ON	ON	OFF	OFF	ON	OFF	OFF	OFF	OFF	OFF
20	OFF	OFF	ON	OFF	ON	OFF	OFF	OFF	OFF	OFF
21	ON	OFF	ON	OFF	ON	OFF	OFF	OFF	OFF	OFF
22	OFF	ON	ON	OFF	ON	OFF	OFF	OFF	OFF	OFF
23	ON	ON	ON	OFF	ON	OFF	OFF	OFF	OFF	OFF
24	OFF	OFF	OFF	ON	ON	OFF	OFF	OFF	OFF	OFF
25	ON	OFF	OFF	ON	ON	OFF	OFF	OFF	OFF	OFF
26	OFF	ON	OFF	ON	ON	OFF	OFF	OFF	OFF	OFF
27	ON	ON	OFF	ON	ON	OFF	OFF	OFF	OFF	OFF
28	OFF	OFF	ON	ON	ON	OFF	OFF	OFF	OFF	OFF
29	ON	OFF	ON	ON	ON	OFF	OFF	OFF	OFF	OFF
30	OFF	ON	ON	ON	ON	OFF	OFF	OFF	OFF	OFF
31	ON	ON	ON	ON	ON	OFF	OFF	OFF	OFF	OFF
32	OFF	OFF	OFF	OFF	OFF	ON	OFF	OFF	OFF	OFF
33	ON	OFF	OFF	OFF	OFF	ON	OFF	OFF	OFF	OFF

ID No.	SWITCH SETTING									
	SW-1	SW-2	SW-3	SW-4	SW-5	SW-6	SW-7	SW-8	SW-9	SW-10
34	OFF	ON	OFF	OFF	OFF	ON	OFF	OFF	OFF	OFF
35	ON	ON	OFF	OFF	OFF	ON	OFF	OFF	OFF	OFF
36	OFF	OFF	ON	OFF	OFF	ON	OFF	OFF	OFF	OFF
37	ON	OFF	ON	OFF	OFF	ON	OFF	OFF	OFF	OFF
38	OFF	ON	ON	OFF	OFF	ON	OFF	OFF	OFF	OFF
39	ON	ON	ON	OFF	OFF	ON	OFF	OFF	OFF	OFF
40	OFF	OFF	OFF	ON	OFF	ON	OFF	OFF	OFF	OFF
41	ON	OFF	OFF	ON	OFF	ON	OFF	OFF	OFF	OFF
42	OFF	ON	OFF	ON	OFF	ON	OFF	OFF	OFF	OFF
43	ON	ON	OFF	ON	OFF	ON	OFF	OFF	OFF	OFF
44	OFF	OFF	ON	ON	OFF	ON	OFF	OFF	OFF	OFF
45	ON	OFF	ON	ON	OFF	ON	OFF	OFF	OFF	OFF
46	OFF	ON	ON	ON	OFF	ON	OFF	OFF	OFF	OFF
47	ON	ON	ON	ON	OFF	ON	OFF	OFF	OFF	OFF
48	OFF	OFF	OFF	OFF	ON	ON	OFF	OFF	OFF	OFF
49	ON	OFF	OFF	OFF	ON	ON	OFF	OFF	OFF	OFF
50	OFF	ON	OFF	OFF	ON	ON	OFF	OFF	OFF	OFF
51	ON	ON	OFF	OFF	ON	ON	OFF	OFF	OFF	OFF
52	OFF	OFF	ON	OFF	ON	ON	OFF	OFF	OFF	OFF
53	ON	OFF	ON	OFF	ON	ON	OFF	OFF	OFF	OFF
54	OFF	ON	ON	OFF	ON	ON	OFF	OFF	OFF	OFF
55	ON	ON	ON	OFF	ON	ON	OFF	OFF	OFF	OFF
56	OFF	OFF	OFF	ON	ON	ON	OFF	OFF	OFF	OFF
57	ON	OFF	OFF	ON	ON	ON	OFF	OFF	OFF	OFF
58	OFF	ON	OFF	ON	ON	ON	OFF	OFF	OFF	OFF
59	ON	ON	OFF	ON	ON	ON	OFF	OFF	OFF	OFF
60	OFF	OFF	ON	ON	ON	ON	OFF	OFF	OFF	OFF
61	ON	OFF	ON	ON	ON	ON	OFF	OFF	OFF	OFF
62	OFF	ON	ON	ON	ON	ON	OFF	OFF	OFF	OFF
63	ON	ON	ON	ON	ON	ON	OFF	OFF	OFF	OFF
64	OFF	OFF	OFF	OFF	OFF	OFF	ON	OFF	OFF	OFF
65	ON	OFF	OFF	OFF	OFF	OFF	ON	OFF	OFF	OFF
66	OFF	ON	OFF	OFF	OFF	OFF	ON	OFF	OFF	OFF
67	ON	ON	OFF	OFF	OFF	OFF	ON	OFF	OFF	OFF
68	OFF	OFF	ON	OFF	OFF	OFF	ON	OFF	OFF	OFF
69	ON	OFF	ON	OFF	OFF	OFF	ON	OFF	OFF	OFF
70	OFF	ON	ON	OFF	OFF	OFF	ON	OFF	OFF	OFF
71	ON	ON	ON	OFF	OFF	OFF	ON	OFF	OFF	OFF
72	OFF	OFF	OFF	ON	OFF	OFF	ON	OFF	OFF	OFF
73	ON	OFF	OFF	ON	OFF	OFF	ON	OFF	OFF	OFF

ID No.	SWITCH SETTING									
	SW-1	SW-2	SW-3	SW-4	SW-5	SW-6	SW-7	SW-8	SW-9	SW-10
74	OFF	ON	OFF	ON	OFF	OFF	ON	OFF	OFF	OFF
75	ON	ON	OFF	ON	OFF	OFF	ON	OFF	OFF	OFF
76	OFF	OFF	ON	ON	OFF	OFF	ON	OFF	OFF	OFF
77	ON	OFF	ON	ON	OFF	OFF	ON	OFF	OFF	OFF
78	OFF	ON	ON	ON	OFF	OFF	ON	OFF	OFF	OFF
79	ON	ON	ON	ON	OFF	OFF	ON	OFF	OFF	OFF
80	OFF	OFF	OFF	OFF	ON	OFF	ON	OFF	OFF	OFF
81	ON	OFF	OFF	OFF	ON	OFF	ON	OFF	OFF	OFF
82	OFF	ON	OFF	OFF	ON	OFF	ON	OFF	OFF	OFF
83	ON	ON	OFF	OFF	ON	OFF	ON	OFF	OFF	OFF
84	OFF	OFF	ON	OFF	ON	OFF	ON	OFF	OFF	OFF
85	ON	OFF	ON	OFF	ON	OFF	ON	OFF	OFF	OFF
86	OFF	ON	ON	OFF	ON	OFF	ON	OFF	OFF	OFF
87	ON	ON	ON	OFF	ON	OFF	ON	OFF	OFF	OFF
88	OFF	OFF	OFF	ON	ON	OFF	ON	OFF	OFF	OFF
89	ON	OFF	OFF	ON	ON	OFF	ON	OFF	OFF	OFF
90	OFF	ON	OFF	ON	ON	OFF	ON	OFF	OFF	OFF
91	ON	ON	OFF	ON	ON	OFF	ON	OFF	OFF	OFF
92	OFF	OFF	ON	ON	ON	OFF	ON	OFF	OFF	OFF
93	ON	OFF	ON	ON	ON	OFF	ON	OFF	OFF	OFF
94	OFF	ON	ON	ON	ON	OFF	ON	OFF	OFF	OFF
95	ON	ON	ON	ON	ON	OFF	ON	OFF	OFF	OFF
96	OFF	OFF	OFF	OFF	OFF	ON	ON	OFF	OFF	OFF
97	ON	OFF	OFF	OFF	OFF	ON	ON	OFF	OFF	OFF
98	OFF	ON	OFF	OFF	OFF	ON	ON	OFF	OFF	OFF
99	ON	ON	OFF	OFF	OFF	ON	ON	OFF	OFF	OFF
100	OFF	OFF	ON	OFF	OFF	ON	ON	OFF	OFF	OFF
101	ON	OFF	ON	OFF	OFF	ON	ON	OFF	OFF	OFF
102	OFF	ON	ON	OFF	OFF	ON	ON	OFF	OFF	OFF
103	ON	ON	ON	OFF	OFF	ON	ON	OFF	OFF	OFF
104	OFF	OFF	OFF	ON	OFF	ON	ON	OFF	OFF	OFF
105	ON	OFF	OFF	ON	OFF	ON	ON	OFF	OFF	OFF
106	OFF	ON	OFF	ON	OFF	ON	ON	OFF	OFF	OFF
107	ON	ON	OFF	ON	OFF	ON	ON	OFF	OFF	OFF
108	OFF	OFF	ON	ON	OFF	ON	ON	OFF	OFF	OFF
109	ON	OFF	ON	ON	OFF	ON	ON	OFF	OFF	OFF
110	OFF	ON	ON	ON	OFF	ON	ON	OFF	OFF	OFF
111	ON	ON	ON	ON	OFF	ON	ON	OFF	OFF	OFF
112	OFF	OFF	OFF	OFF	ON	ON	ON	OFF	OFF	OFF
113	ON	OFF	OFF	OFF	ON	ON	ON	OFF	OFF	OFF

ID No.	SWITCH SETTING									
	SW-1	SW-2	SW-3	SW-4	SW-5	SW-6	SW-7	SW-8	SW-9	SW-10
114	OFF	ON	OFF	OFF	ON	ON	ON	OFF	OFF	OFF
115	ON	ON	OFF	OFF	ON	ON	ON	OFF	OFF	OFF
116	OFF	OFF	ON	OFF	ON	ON	ON	OFF	OFF	OFF
117	ON	OFF	ON	OFF	ON	ON	ON	OFF	OFF	OFF
118	OFF	ON	ON	OFF	ON	ON	ON	OFF	OFF	OFF
119	ON	ON	ON	OFF	ON	ON	ON	OFF	OFF	OFF
120	OFF	OFF	OFF	ON	ON	ON	ON	OFF	OFF	OFF
121	ON	OFF	OFF	ON	ON	ON	ON	OFF	OFF	OFF
122	OFF	ON	OFF	ON	ON	ON	ON	OFF	OFF	OFF
123	ON	ON	OFF	ON	ON	ON	ON	OFF	OFF	OFF
124	OFF	OFF	ON	ON	ON	ON	ON	OFF	OFF	OFF
125	ON	OFF	ON	ON	ON	ON	ON	OFF	OFF	OFF
126	OFF	ON	ON	ON	ON	ON	ON	OFF	OFF	OFF
127	ON	ON	ON	ON	ON	ON	ON	OFF	OFF	OFF
128	OFF	OFF	OFF	OFF	OFF	OFF	OFF	ON	OFF	OFF
129	ON	OFF	OFF	OFF	OFF	OFF	OFF	ON	OFF	OFF
130	OFF	ON	OFF	OFF	OFF	OFF	OFF	ON	OFF	OFF
131	ON	ON	OFF	OFF	OFF	OFF	OFF	ON	OFF	OFF
132	OFF	OFF	ON	OFF	OFF	OFF	OFF	ON	OFF	OFF
133	ON	OFF	ON	OFF	OFF	OFF	OFF	ON	OFF	OFF
134	OFF	ON	ON	OFF	OFF	OFF	OFF	ON	OFF	OFF
135	ON	ON	ON	OFF	OFF	OFF	OFF	ON	OFF	OFF
136	OFF	OFF	OFF	ON	OFF	OFF	OFF	ON	OFF	OFF
137	ON	OFF	OFF	ON	OFF	OFF	OFF	ON	OFF	OFF
138	OFF	ON	OFF	ON	OFF	OFF	OFF	ON	OFF	OFF
139	ON	ON	OFF	ON	OFF	OFF	OFF	ON	OFF	OFF
140	OFF	OFF	ON	ON	OFF	OFF	OFF	ON	OFF	OFF
141	ON	OFF	ON	ON	OFF	OFF	OFF	ON	OFF	OFF
142	OFF	ON	ON	ON	OFF	OFF	OFF	ON	OFF	OFF
143	ON	ON	ON	ON	OFF	OFF	OFF	ON	OFF	OFF
144	OFF	OFF	OFF	OFF	ON	OFF	OFF	ON	OFF	OFF
145	ON	OFF	OFF	OFF	ON	OFF	OFF	ON	OFF	OFF
146	OFF	ON	OFF	OFF	ON	OFF	OFF	ON	OFF	OFF
147	ON	ON	OFF	OFF	ON	OFF	OFF	ON	OFF	OFF
148	OFF	OFF	ON	OFF	ON	OFF	OFF	ON	OFF	OFF
149	ON	OFF	ON	OFF	ON	OFF	OFF	ON	OFF	OFF
150	OFF	ON	ON	OFF	ON	OFF	OFF	ON	OFF	OFF
151	ON	ON	ON	OFF	ON	OFF	OFF	ON	OFF	OFF
152	OFF	OFF	OFF	ON	ON	OFF	OFF	ON	OFF	OFF
153	ON	OFF	OFF	ON	ON	OFF	OFF	ON	OFF	OFF

ID No.	SWITCH SETTING									
	SW-1	SW-2	SW-3	SW-4	SW-5	SW-6	SW-7	SW-8	SW-9	SW-10
154	OFF	ON	OFF	ON	ON	OFF	OFF	ON	OFF	OFF
155	ON	ON	OFF	ON	ON	OFF	OFF	ON	OFF	OFF
156	OFF	OFF	ON	ON	ON	OFF	OFF	ON	OFF	OFF
157	ON	OFF	ON	ON	ON	OFF	OFF	ON	OFF	OFF
158	OFF	ON	ON	ON	ON	OFF	OFF	ON	OFF	OFF
159	ON	ON	ON	ON	ON	OFF	OFF	ON	OFF	OFF
160	OFF	OFF	OFF	OFF	OFF	ON	OFF	ON	OFF	OFF
161	ON	OFF	OFF	OFF	OFF	ON	OFF	ON	OFF	OFF
162	OFF	ON	OFF	OFF	OFF	ON	OFF	ON	OFF	OFF
163	ON	ON	OFF	OFF	OFF	ON	OFF	ON	OFF	OFF
164	OFF	OFF	ON	OFF	OFF	ON	OFF	ON	OFF	OFF
165	ON	OFF	ON	OFF	OFF	ON	OFF	ON	OFF	OFF
166	OFF	ON	ON	OFF	OFF	ON	OFF	ON	OFF	OFF
167	ON	ON	ON	OFF	OFF	ON	OFF	ON	OFF	OFF
168	OFF	OFF	OFF	ON	OFF	ON	OFF	ON	OFF	OFF
169	ON	OFF	OFF	ON	OFF	ON	OFF	ON	OFF	OFF
170	OFF	ON	OFF	ON	OFF	ON	OFF	ON	OFF	OFF
171	ON	ON	OFF	ON	OFF	ON	OFF	ON	OFF	OFF
172	OFF	OFF	ON	ON	OFF	ON	OFF	ON	OFF	OFF
173	ON	OFF	ON	ON	OFF	ON	OFF	ON	OFF	OFF
174	OFF	ON	ON	ON	OFF	ON	OFF	ON	OFF	OFF
175	ON	ON	ON	ON	OFF	ON	OFF	ON	OFF	OFF
176	OFF	OFF	OFF	OFF	ON	ON	OFF	ON	OFF	OFF
177	ON	OFF	OFF	OFF	ON	ON	OFF	ON	OFF	OFF
178	OFF	ON	OFF	OFF	ON	ON	OFF	ON	OFF	OFF
179	ON	ON	OFF	OFF	ON	ON	OFF	ON	OFF	OFF
180	OFF	OFF	ON	OFF	ON	ON	OFF	ON	OFF	OFF
181	ON	OFF	ON	OFF	ON	ON	OFF	ON	OFF	OFF
182	OFF	ON	ON	OFF	ON	ON	OFF	ON	OFF	OFF
183	ON	ON	ON	OFF	ON	ON	OFF	ON	OFF	OFF
184	OFF	OFF	OFF	ON	ON	ON	OFF	ON	OFF	OFF
185	ON	OFF	OFF	ON	ON	ON	OFF	ON	OFF	OFF
186	OFF	ON	OFF	ON	ON	ON	OFF	ON	OFF	OFF
187	ON	ON	OFF	ON	ON	ON	OFF	ON	OFF	OFF
188	OFF	OFF	ON	ON	ON	ON	OFF	ON	OFF	OFF
189	ON	OFF	ON	ON	ON	ON	OFF	ON	OFF	OFF
190	OFF	ON	ON	ON	ON	ON	OFF	ON	OFF	OFF
191	ON	ON	ON	ON	ON	ON	OFF	ON	OFF	OFF
192	OFF	OFF	OFF	OFF	OFF	OFF	ON	ON	OFF	OFF
193	ON	OFF	OFF	OFF	OFF	OFF	ON	ON	OFF	OFF

ID No.	SWITCH SETTING									
	SW-1	SW-2	SW-3	SW-4	SW-5	SW-6	SW-7	SW-8	SW-9	SW-10
194	OFF	ON	OFF	OFF	OFF	OFF	ON	ON	OFF	OFF
195	ON	ON	OFF	OFF	OFF	OFF	ON	ON	OFF	OFF
196	OFF	OFF	ON	OFF	OFF	OFF	ON	ON	OFF	OFF
197	ON	OFF	ON	OFF	OFF	OFF	ON	ON	OFF	OFF
198	OFF	ON	ON	OFF	OFF	OFF	ON	ON	OFF	OFF
199	ON	ON	ON	OFF	OFF	OFF	ON	ON	OFF	OFF
200	OFF	OFF	OFF	ON	OFF	OFF	ON	ON	OFF	OFF
201	ON	OFF	OFF	ON	OFF	OFF	ON	ON	OFF	OFF
202	OFF	ON	OFF	ON	OFF	OFF	ON	ON	OFF	OFF
203	ON	ON	OFF	ON	OFF	OFF	ON	ON	OFF	OFF
204	OFF	OFF	ON	ON	OFF	OFF	ON	ON	OFF	OFF
205	ON	OFF	ON	ON	OFF	OFF	ON	ON	OFF	OFF
206	OFF	ON	ON	ON	OFF	OFF	ON	ON	OFF	OFF
207	ON	ON	ON	ON	OFF	OFF	ON	ON	OFF	OFF
208	OFF	OFF	OFF	OFF	ON	OFF	ON	ON	OFF	OFF
209	ON	OFF	OFF	OFF	ON	OFF	ON	ON	OFF	OFF
210	OFF	ON	OFF	OFF	ON	OFF	ON	ON	OFF	OFF
211	ON	ON	OFF	OFF	ON	OFF	ON	ON	OFF	OFF
212	OFF	OFF	ON	OFF	ON	OFF	ON	ON	OFF	OFF
213	ON	OFF	ON	OFF	ON	OFF	ON	ON	OFF	OFF
214	OFF	ON	ON	OFF	ON	OFF	ON	ON	OFF	OFF
215	ON	ON	ON	OFF	ON	OFF	ON	ON	OFF	OFF
216	OFF	OFF	OFF	ON	ON	OFF	ON	ON	OFF	OFF
217	ON	OFF	OFF	ON	ON	OFF	ON	ON	OFF	OFF
218	OFF	ON	OFF	ON	ON	OFF	ON	ON	OFF	OFF
219	ON	ON	OFF	ON	ON	OFF	ON	ON	OFF	OFF
220	OFF	OFF	ON	ON	ON	OFF	ON	ON	OFF	OFF
221	ON	OFF	ON	ON	ON	OFF	ON	ON	OFF	OFF
222	OFF	ON	ON	ON	ON	OFF	ON	ON	OFF	OFF
223	ON	ON	ON	ON	ON	OFF	ON	ON	OFF	OFF
224	OFF	OFF	OFF	OFF	OFF	ON	ON	ON	OFF	OFF
225	ON	OFF	OFF	OFF	OFF	ON	ON	ON	OFF	OFF
226	OFF	ON	OFF	OFF	OFF	ON	ON	ON	OFF	OFF
227	ON	ON	OFF	OFF	OFF	ON	ON	ON	OFF	OFF
228	OFF	OFF	ON	OFF	OFF	ON	ON	ON	OFF	OFF
229	ON	OFF	ON	OFF	OFF	ON	ON	ON	OFF	OFF
230	OFF	ON	ON	OFF	OFF	ON	ON	ON	OFF	OFF
231	ON	ON	ON	OFF	OFF	ON	ON	ON	OFF	OFF
232	OFF	OFF	OFF	ON	OFF	ON	ON	ON	OFF	OFF
233	ON	OFF	OFF	ON	OFF	ON	ON	ON	OFF	OFF

ID No.	SWITCH SETTING									
	SW-1	SW-2	SW-3	SW-4	SW-5	SW-6	SW-7	SW-8	SW-9	SW-10
234	OFF	ON	OFF	ON	OFF	ON	ON	ON	OFF	OFF
235	ON	ON	OFF	ON	OFF	ON	ON	ON	OFF	OFF
236	OFF	OFF	ON	ON	OFF	ON	ON	ON	OFF	OFF
237	ON	OFF	ON	ON	OFF	ON	ON	ON	OFF	OFF
238	OFF	ON	ON	ON	OFF	ON	ON	ON	OFF	OFF
239	ON	ON	ON	ON	OFF	ON	ON	ON	OFF	OFF
240	OFF	OFF	OFF	OFF	ON	ON	ON	ON	OFF	OFF
241	ON	OFF	OFF	OFF	ON	ON	ON	ON	OFF	OFF
242	OFF	ON	OFF	OFF	ON	ON	ON	ON	OFF	OFF
243	ON	ON	OFF	OFF	ON	ON	ON	ON	OFF	OFF
244	OFF	OFF	ON	OFF	ON	ON	ON	ON	OFF	OFF
245	ON	OFF	ON	OFF	ON	ON	ON	ON	OFF	OFF
246	OFF	ON	ON	OFF	ON	ON	ON	ON	OFF	OFF
247	ON	ON	ON	OFF	ON	ON	ON	ON	OFF	OFF
248	OFF	OFF	OFF	ON	ON	ON	ON	ON	OFF	OFF
249	ON	OFF	OFF	ON	ON	ON	ON	ON	OFF	OFF
250	OFF	ON	OFF	ON	ON	ON	ON	ON	OFF	OFF
251	ON	ON	OFF	ON	ON	ON	ON	ON	OFF	OFF
252	OFF	OFF	ON	ON	ON	ON	ON	ON	OFF	OFF
253	ON	OFF	ON	ON	ON	ON	ON	ON	OFF	OFF
254	OFF	ON	ON	ON	ON	ON	ON	ON	OFF	OFF
255	ON	ON	ON	ON	ON	ON	ON	ON	OFF	OFF

Protocol Setup

Protocol No.	SWITCH SETTING					
	SW-1	SW-2	SW-3	SW-4	SW-5	SW-6
0	OFF	OFF	OFF	OFF	OFF	OFF
1	ON	OFF	OFF	OFF	OFF	OFF
2	OFF	ON	OFF	OFF	OFF	OFF
3	ON	ON	OFF	OFF	OFF	OFF
4	OFF	OFF	ON	OFF	OFF	OFF
5	ON	OFF	ON	OFF	OFF	OFF
6	OFF	ON	ON	OFF	OFF	OFF
7	ON	ON	ON	OFF	OFF	OFF
8	OFF	OFF	OFF	ON	OFF	OFF
9	ON	OFF	OFF	ON	OFF	OFF
10	OFF	ON	OFF	ON	OFF	OFF
11	ON	ON	OFF	ON	OFF	OFF
12	OFF	OFF	ON	ON	OFF	OFF
13	ON	OFF	ON	ON	OFF	OFF
14	OFF	ON	ON	ON	OFF	OFF
15	ON	ON	ON	ON	OFF	OFF
16	OFF	OFF	OFF	OFF	ON	OFF
17	ON	OFF	OFF	OFF	ON	OFF
18	OFF	ON	OFF	OFF	ON	OFF
19	ON	ON	OFF	OFF	ON	OFF
20	OFF	OFF	ON	OFF	ON	OFF
21	ON	OFF	ON	OFF	ON	OFF
22	OFF	ON	ON	OFF	ON	OFF
23	ON	ON	ON	OFF	ON	OFF

Appendix C: OSD Menu Notes

The following OSD menu table is provided for users to record various camera settings.

Item	Layer 1	Layer 2	Layer 3	Notes	
LANGUAGE	<ENGLISH>, <PORTUGUESE>, <SPANISH>, <FRENCH>, <GERMAN>, <ITALIAN>				
DEFAULT CAMERA	<ON>, <OFF>				
BACKLIGHT	<ON>, <OFF>				
FOCUS	<AUTO>	AF MODE <NORMAL>, <Z. TRIG.>, <PTZ TRIG.>			
	<MANUAL>	EXIT + SAVE: YES			
AE MODE	EXPOSURE COMP.	<OFF>, EXPOSURE VALUE: <-10.5dB> ~ <10.5dB>			
		EXIT + SAVE: YES			
	AE MODE	AUTO	BRIGHT VALUE; SHUTTER SPEED; IRIS VALUE; GAIN VALUE: AUTO		
		EXIT + SAVE: YES			
		SHUTTER	SHUTTER SPEED PAL:<1/50>~ <1/10000> SEC. NTSC: <1/60>~ <1/10000> SEC.		
		EXIT + SAVE: YES			
	IRIS	IRIS VALUE <F1.6>			
	EXIT + SAVE: YES				
	MANUAL	BRIGHT VALUE: AUTO			
		SHUTTER SPEED PAL:<1/50> ~ <1/10000> SEC. NTSC: <1/60> ~ <1/10000> SEC.			
IRIS VALUE <F1.6>					
GAIN VALUE <-3>dB ~ <28>dB					
EXIT + SAVE: YES					
EXIT+ SAVE:		YES			
WBC MODE	AUTO (Auto White Balance)				
	INDOOR				
	OUTDOOR				
	ATW (Auto-tracing WBC)				
	MANUAL	R GAIN <000> ~ <127> B GAIN <000> ~ <127>			
EXIT + SAVE: YES					
SETUP MENU 1	ENTER	ZOOM SPEED	<8>		
		DIGITAL ZOOM	<ON>, <OFF>		
		SLOW SHUTTER	<ON>, <OFF>		
		D.N.R.	2D N.R. <ON>, <OFF>		
			3D N.R. <ON>, <OFF>		
		EXIT + SAVE: YES			
		IMAGE INVERSE	<ON>, <OFF>		
		FREEZE	<ON>, <OFF>		
APERTURE	<01> ~ <16>				
EXIT		<YES>			
SETUP MENU 2	ENTER	FLIP	<OFF>, <M.E.>, <IMAGE>		
		EXIT + SET: YES			
ANGLE ADJUSTER	ADJUST MIN ANGL <-10> ~ <+10> DEG				

Item	Layer 1	Layer 2	Layer 3	Notes	
			ADJUST MAX ANGL <080> ~ <100> DEG		
			EXIT + SET: YES		
		SPEED BY ZOOM	<ON>, <OFF>		
		AUTO CALI.	<ON>, <OFF>		
		PASSWORD	<ON>, <OFF>		
		OSD AUTO CLOSE	<OFF>, <5> ~ <30> SEC.		
		SYSTEM RESET	SYSTEM RESET <YES>		
			DEFAULT SYSTEM <YES>		
	EXIT	<YES>			
ID DISPLAY	<ON>, <OFF>				
TITLE DISPLAY	<ON>, <OFF>				
TITLE SETTING	<01> ~ <16>				
PRESET	PRESET SET	<001>~<256>			
	PRESET RUN	<001>~<256>			
	EXIT	YES			
SEQUENCE	ENTER	SEQUENCE LINE	<1> ~ <8>		
		SEQUENCE POINT	<01> ~ <64>		
		PRESET POS.	<001> ~ <255>, <END>		
		SPEED	<01> ~ <15>		
		DWELL TIME	<000> ~ <127> SEC.		
		RUN SEQUENCE	ENTER		
		EXIT	<YES>		
AUTOPAN	ENTER	AUTOPAN LINE	<1> ~ <4>		
		START POINT	<TO FIND>, <TO SAVE>		
		END POINT	<TO FIND>, <TO SAVE>		
		DIRECTION	<RIGHT>, <LEFT>		
		SPEED	<01> ~ <04>		
		RUN AUTOPAN			
		EXIT			
CRUISE	ENTER	CRUISE LINE	<1> ~ <8>		
		RECORD START	ENTER		
		RECORD END	ENTER		
		RUN CRUISE	ENTER		
		EXIT	ENTER		
HOME SETTING	ENTER	HOME FUNCTION	<ON>, <OFF>		
		SELECT MODE	PRESET		
			SEQUENCE		
			AUTOPAN		
			CRUISE		
		PRESET POINT	<001> ~ <256>		
		SEQUENCE LINE	<001> ~ <008>		
		AUTOPAN LINE	<001> ~ <004>		
CRUISE LINE	<001> ~ <008>				
RETURN TIME	<001> ~ <128> MIN.				
GO	ENTER				
EXIT	YES				
IR FUNCTION	AUTO	THRESHOLD <MID>, <HI>, <LOW>			
		EXIT + SAVE: YES			
	MANUAL	IR MANUAL: <ON>, <OFF>			
		EXIT + SAVE: YES			
ALARM SETTING	ENTER	ALARM PIN	<1> ~ <8>		
		ALARM SWITCH	<ON>, <OFF>		
		ALARM TYPE	<NO>, <NC>		
		ALARM ACTION	PRESET		
		SEQUENCE			

Item	Layer 1	Layer 2	Layer 3	Notes	
			AUTOPAN		
			CRUISE		
		PRESET POINT SEQUENCE LINE AUTOPAN LINE CRUISE LINE	<001> ~ <256> <001> ~ <008> <001> ~ <004> <001> ~ <008>		
		DWELL TIME	<001> ~ <127> SEC., <ALWAYS>		
		EXIT	YES		
ALARM DETECT	DETECT SWITCH	<ON>, <OFF>			
	DETECT MODE	<MOTION>			
	BLOCK MODE	<NONE>, <ON>, <OFF>			
	FRAME SET	NONE; MOTION: <01> ~ <04>			
	FRAME DISABLE	NONE; MOTION: <01> ~ <04>			
	THRESHOLD	NONE; MOTION: <001> ~ <255>			
	EXIT	YES			
WDR FUNCTION	<ON>, <OFF>				
PRIVACY MASK	PRIVACY SWITCH	<ON>, <OFF>			
	TRANSPARENCY	<ON>, <OFF>			
	COLOR	<BLACK>, <WHITE>, <RED>, <GREEN>, <BLUE>, <CYAN>, <YELLOW>, <MAGENT A>			
	SET MASK	<01> ~ <16>	H CENTER: L/R V CENTER: D/U H SIZE <000> ~ <080> V SIZE <000> ~ <060> EXIT + SAVE		
	CLEAR MASK	<01> ~ <16>			
	EXIT	YES			
	TIME SETTING	ENTER	TIME DISPLAY	<ON>, <OFF>	
SET YEAR			<00> ~ <99>		
SET MONTH			<01> ~ <12>		
SET DAY			<01> ~ <31>		
SET HOUR			<00> ~ <23>		
SET MINUTE			<00> ~ <59>		
EXIT+SAVE			YES		
SCHEDULE	SCHEDULE SWITCH	<ON>, <OFF>		OFF	
	POINT	<01> ~ <32>		01	
	HOUR	<00> ~ <23>		00	
	MINUTE	<00> ~ <59>		00	
	MODE	NONE	NO FUNCTION		
		PRESET	PRESET POINT <001> ~ <256>		
		SEQUENCE	SEQUENCE LINE <001> ~ <008>		
		AUTOPAN	AUTOPAN LINE <001> ~ <004>		
		CRUISE	CRUISE LINE <001> ~ <008>		
	IR FUNC.	IR FUNCTION <AUTO>, <ON>, <OFF>			
SCHEDULE RESET	YES				
EXIT OSD	YES				